

Preface

Thanks for purchasing Quick-opener FORD product and before using this product, please read the instruction manual and please operate according to it!

Description

- 1. Dialing lever
- 2. 6 directions screw
(lock opening pressing lever)
- 3. Knob
- 4. Knob gauge

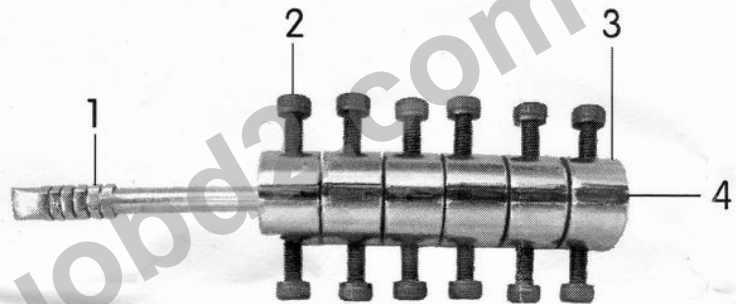

Car brand and key applicable

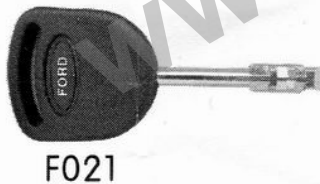

Applicable for Ford Transit, Ford Mondeo, Jaguar series

Using method

● **Opening method:**

Set the 6 screws on the tool in one line and insert them into the lock heart (See Picture 1); check the direction first turning left or right as well as the Moving Blade (the screws which are not movable, No. 4 blade) and the cannot press too much force while opening the lock

Because there are one deep and one low flute in each lock blade (the low flute is narrow and shallow (see Picture 4); the deep flute is wide and dark (see Picture 4), when the other screws reach the position, there will be a sound of "KA" and then revolve the screws to detect the seam size of the screws. The seam of low flute is small and it is big for the deep flute (the deep flute should be the right opening place). One thing to pay attention to is that when you turn other blades, it might bring along the initial setting blade. Thus, please use other fingers to press the setting blade slightly and the other hand to move the blades on the other places..

● **Code reading method:**

After opening the lock heart (see picture 2), now you can see the 6 red knob gauges are not in one line; read the lock blade number according to the knob gauge angle (see picture 3); when the screws in one line, restore and pull out the tool slightly.

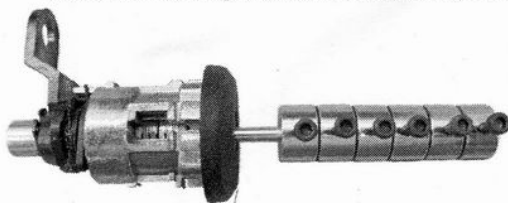

Picture 1
Input Status

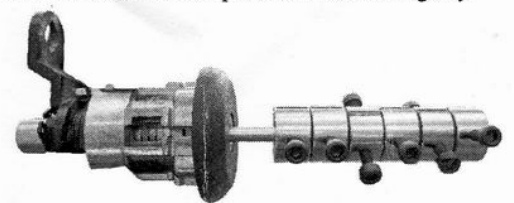

Picture 2
Lock Opening Status

Low Flute Deep Flute

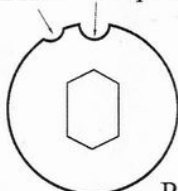

Picture 4

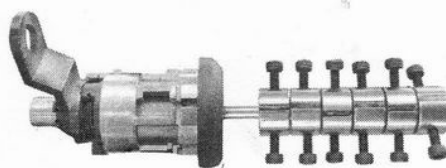

Picture 3
Lock Reading Status

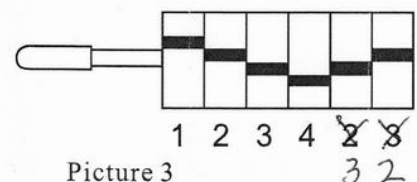

Picture 3