

XTOOL

X100MAX Auto Key Programmer User Manual



Shenzhen Xtooltech Intelligent Co., LTD

Please read this user manual carefully before using the X100MAX Auto Key Programmer. When reading the manual, please pay attention to the words “Note” or “Caution” and read them carefully for appropriate operation.

TRADEMARKS

XTOOL is a registered trademark of Shenzhen Xtooltech Intelligent CO., LTD.

In countries that the trademarks, service marks, domain names, logos and the name of the company are not registered, Xtool claims that it still reserves the ownership of the unregistered trademarks, service marks, domain names, logos and the company name. All other marks for the other products and the company’s name mentioned in the manual still belong to the original registered company.

You may not use the trademarks, service marks, domain names, logo and company name of Xtool or other companies mentioned without written permission from the trademark holder.

Xtool reserves the right for the final interpretation of this manual content.

COPYRIGHT

Without the written consent of Shenzhen Xtooltech Intelligent Co., Ltd., any company or individual shall not copy or backup this operation manual in any form (electronic, mechanical, photocopying, recording or other forms).

DECLARATION

This manual is designed for the usage of X100MAX Auto Key Programmer, and provides operating instructions and product descriptions for users of the X100MAX Auto Key Programmer.

No part of this manual can be reproduced, stored in a retrieval system or transmitted, in any form or by any means (electronic, mechanical, photocopying, recording, or otherwise), without the prior written permission of Xtool.

Use the device only as described in this manual. Xtool is not responsible for any consequences of violating the laws and regulations caused by using the product or its data information

Xtool shall not be liable for any incidental or consequential damages or for any economic consequential damages arising from the accidents of individual users and the third parties, misuse or abuse of the device, unauthorized change or repair of the device, or the

failure made by the user not to use the product according to the manual.

All information, specifications and illustrations in this manual are based on the latest configurations and functions available at the time of printing. Xtool reserves the right to make changes at any time without notice.

OPERATION INSTRUCTIONS

For safe operation, please follow the instructions below:

- Keep the device away from heat or fumes when you are using it.
- If the vehicle battery contains acid, please keep your hands and skin or fire sources away from the battery during testing.
- Exhaust gas of vehicle contains harmful chemicals, please ensure adequate ventilation.
- Do not touch the cooling system components or exhaust manifolds when engine is running due to the high temperatures reached.
- Make sure the car is securely parked, Neutral is selected or the selector is at P or N position to prevent the vehicle from moving when engine starts.
- Make sure the (DLC) diagnostic link connector is functioning properly before starting the test to avoid damage to the Diagnostic Tablet.

- Do not switch off the power or unplug the connectors during testing, otherwise you may damage the ECU and/or the Diagnostic Tablet.

CAUTIONS!

- Avoid shaking or dismantling the unit as it may damage the internal components.
- Do not use hard or sharp objects to touch the LCD screen;
- Do not use excessive force;
- Do not expose the screen to strong sunlight for a long period.
- Please keep it away from water, moisture, high temperature or very low temperature.
- If necessary, calibrate the screen before testing to ensure the accuracy of LCD performance.
- Keep the main unit away from strong magnetic fields.

AFTERSALES-SERVICES

 E-Mail: supporting@xtooltech.com

 Tel: +86 755 21670995 or +86 755 86267858 (China)

 Official Website: www.xtooltech.com

CONTENT

TRADEMARKS	I
COPYRIGHT	II
DECLARATION.....	II
OPERATION INSTRUCTIONS	III
CAUTIONS!.....	IV
AFTERSALES-SERVICES	IV
1 GENERAL INTRODUCTION.....	4
X100MAX Tablet.....	5
<i>Front View of Tablet.....</i>	<i>5</i>
<i>Back View of Tablet.....</i>	<i>6</i>
<i>Host Ports.....</i>	<i>7</i>
VCI communication box	8
<i>Front/Back View of VCI BOX.....</i>	<i>8</i>
<i>Top/Bottom View of VCI BOX.....</i>	<i>9</i>
KC501 Key & Chip Programmer	9
<i>Exposed view of KC501.....</i>	<i>10</i>
Technical Specifications.....	13
2 GETTING STARTED	14
Activation Guide	14
Main Interface	19
<i>Operation System.....</i>	<i>19</i>
<i>X100MAX App Menu.....</i>	<i>22</i>
<i>Function Buttons.....</i>	<i>23</i>
<i>Navigation Buttons.....</i>	<i>24</i>

	<i>Notification Bar</i>	25
3	UPDATE	26
4	KEY PROGRAMMING	27
	Vehicle Connection	27
	KC501 Connection	28
	Immobilizer Menu.....	29
	Immobilizer Functions	30
	<i>Read PIN code/Pin Code Calculation</i>	30
	<i>Check Number of Keys</i>	33
	<i>Add Keys</i>	34
	<i>All Key Lost</i>	36
5	DIAGNOSIS	38
	Vehicle Selection	38
	Diagnose Functions	40
6	SPECIAL FUNCTIONS	47
	Oil Light Reset	48
	EPB.....	49
	SAS.....	50
	DPF.....	51
	BMS Reset.....	52
	Throttle.....	53
	TPMS Reset.....	53
	ABS Bleeding.....	54
	Injector Coding.....	55

	Gearbox Match	55
	Suspension	56
	Windows Initialization.....	56
	Seat Calibration	57
	Headlight.....	57
	ECU Configuration	57
	*A/F Reset	58
	*Stop/Start Reset	58
	Airbag Reset	58
	Instrument Cluster.....	59
7	REPORT	59
	Report.....	60
	Replay.....	63
	File Manager.....	63
8	SETTINGS	64
	Language.....	65
	Units.....	66
	Bluetooth.....	67
	My Workshop Info	67
	VCI Information.....	68
	About	69
9	REMOTE ASSISTANCE.....	70
	SHENZHEN XTOOLTECH INTELLIGENT CO., LTD	72

1 GENERAL INTRODUCTION

The X100MAX Auto Key Programmer is a professional key programming device, based on the Android operating system. It supports multi-language switching and is suitable for different countries and regions. Equipped with KC501, this auto key programmer supports key programming functions like read PIN code/read immobilizer data/add key/all key lost for various vehicles, and supports basic diagnosis functions and multiple special functions.

X100MAX TABLET

The main unit of the X100MAX is the tablet. It allows you to operate all the key programming and diagnosis functions, and it can also work as a normal Android tablet.

FRONT VIEW OF TABLET

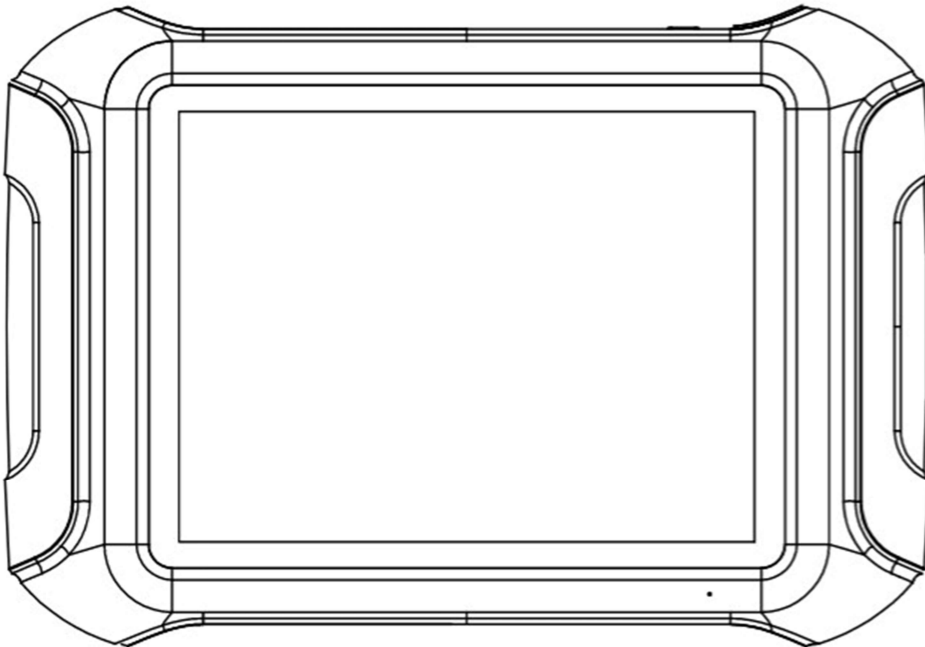

Fig 1-1 Tablet Front View

The front of the tablet is mainly a touchable display screen, you can use your fingers to operate on the screen to finish most of the key programming process.

BACK VIEW OF TABLET

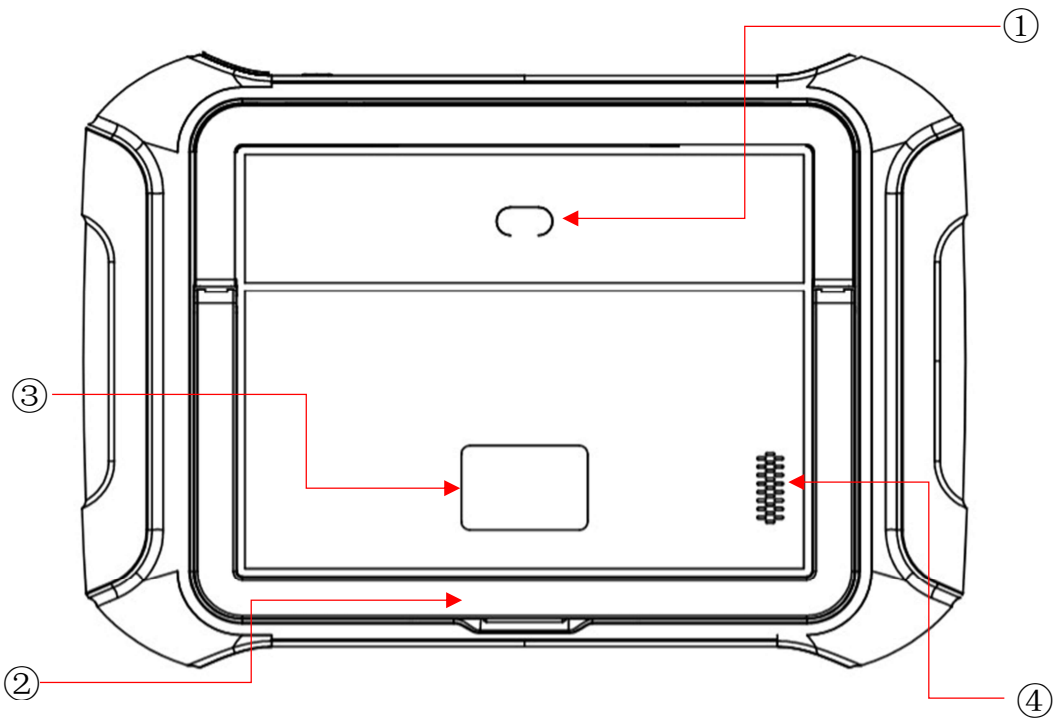

Fig 1-2 Tablet Back View

- ① **Camera:** Used for taking pictures.
- ② **Tablet Holder:** Used to support the tablet, hold the tablet on the steering wheel or adjust of the tablet height as needed.
- ③ **Nameplate:** Show the basic information about tablet such as product name and serial number, etc.
- ④ **Loudspeaker:** It supports external sound playback.

HOST PORTS

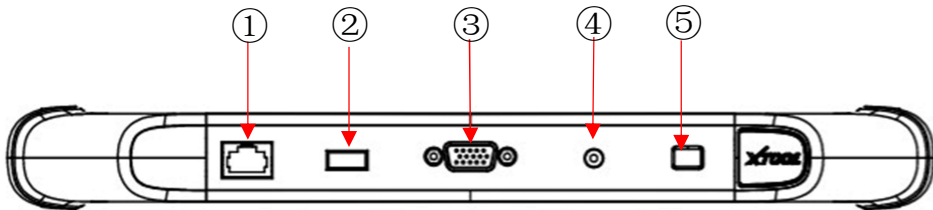

Fig 1-3 Tablet Host Ports

- ① **DOIP port:** Supports ECU programming for vehicles with DOIP protocol. (Doesn't support in X100MAX)
- ② **USB 3.0 port:** Used for data transfer for tablet & PC communication, KC501 connection for key programming, and data transfer with VCI box when working on immobilizer reset process.
- ③ **VGA port:** Diagnostic communication port, which can be used for OBD connection. (Doesn't support in X100MAX)
- ④ **DC charging port:** Charging port, connected to the power adapter to charge the device.
- ⑤ **Power button:** Long press to turn device on/off, short press to switch the device into sleep mode. Hold for about 20 seconds to force shutdown the device.

VCI COMMUNICATION BOX

To communicate with the vehicle via OBD, X100MAX also comes up with a VCI box. The tablet needs Bluetooth connection with VCI box to get access to all the immobilizer & diagnosis software.

① Although some functions (like EEPROM Adapter) will not need you to communicate to vehicle, please power up the VCI box using 12V power adapter to get access to the software.

FRONT/BACK VIEW OF VCI BOX

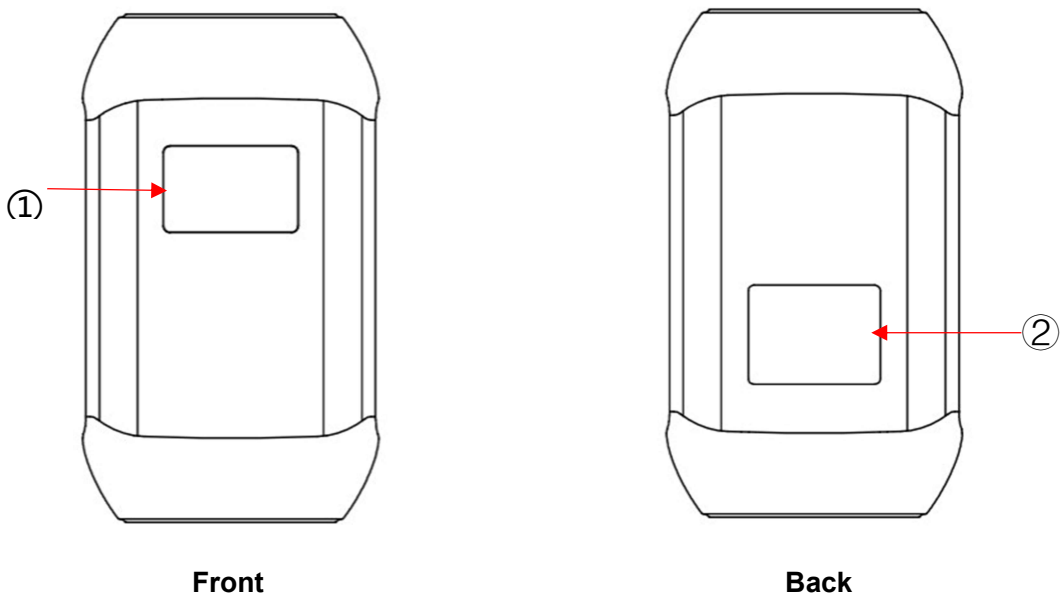

Fig 1-3/1-4 VCI box front/back View

- ① **Display Screen:** Show status of the VCI box like battery voltage, Bluetooth connection and car communication status.
- ② **Nameplate:** Show basic information about the VCI box, like the serial number.

① Make sure that you're using the VCI box that is paired with the tablet, or it will not communicate. The serial number of the VCI box must be the same as the serial number of the tablet.

TOP/BOTTOM VIEW OF VCI BOX



Fig 1-5/1-6 VCI box top/bottom View

- ① **DB15 Port:** Used to connect the VCI box to the OBDII port on the vehicle.
- ② **USB-B Port:** Used to connect the VCI box to the tablet using USB-B to USB3.0 cable.

KC501 KEY & CHIP PROGRAMMER

KC501 is a multipurpose key & chip programmer that supports these functions:

- Read & write car keys & key chip
- Generate dealer keys
- Read remote frequency, chip type & chip ID
- Read & write Mercedes-Benz infrared key
- Read & write MCU/EEPROM chip

This programmer needs to work together with X100MAX tablet or PC.

EXPOSED VIEW OF KC501

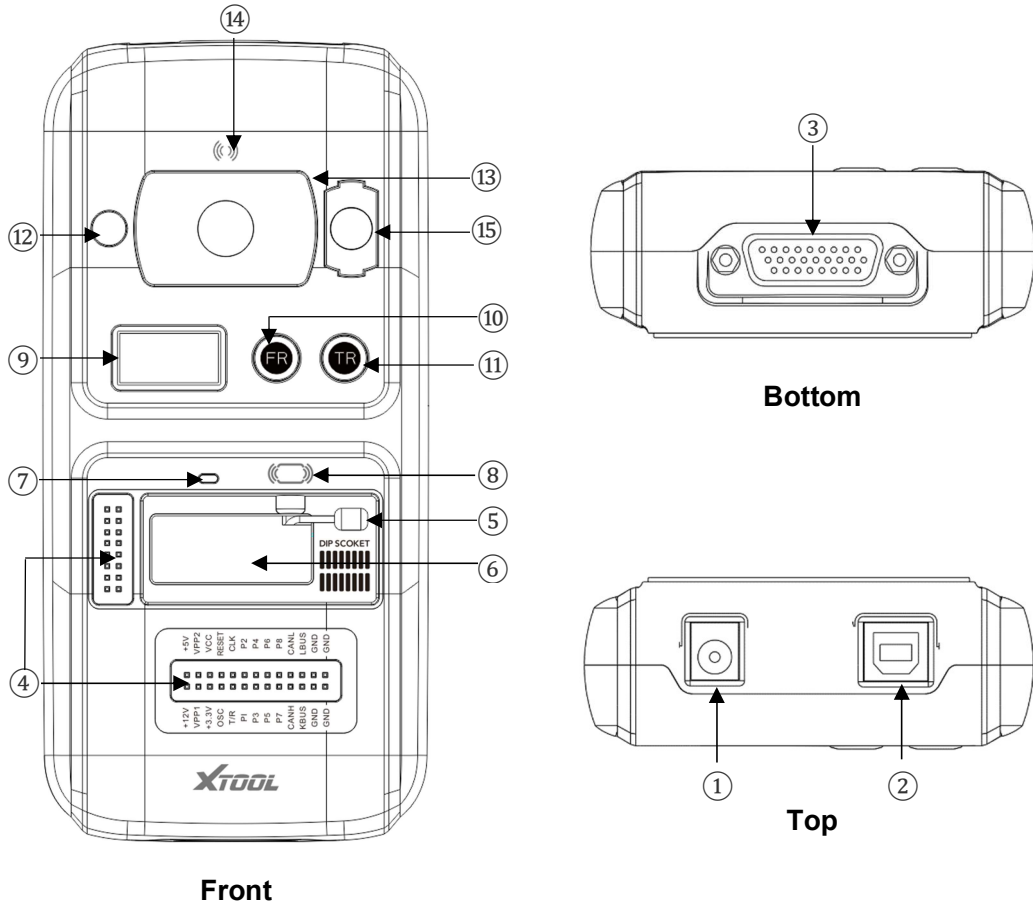

Fig 1-7 KC501 Exposed View

- ① **DC Port:** Provides 12V DC power supply.
 - ① Please connect 12V power supply to KC501 when working on MCU/ECU reading & writing process.
- ② **USB-B Port:** Provides data transmission between KC501 and X100MAX or PC. Also provides 5V power supply when connected.
- ③ **DB 26-Pin Port:** Can be connected with Mercedes-Benz infrared cable, ECU cable, MCU cable and MC9S12 cable.
- ④ **Cross Signal Pins:** Holds the MCU board, MCU spare cable or DIY signal interface.
 - ① The Cross-shaped signal pin is used to place MCU board, MCU spare cable or DIY signal cable to read or write MCU and ECU chips.
- ⑤ **Locker:** Locks the EEPROM component transponder slot to make sure it is functioning.
- ⑥ **EEPROM Component Transponder Slot:** Holds the EEPROM plug-in transponder or EEPROM socket, used to read & write EEPROM chip.
- ⑦ **Status LED:** Indicates current operating status.
- ⑧ **IC Card Induction Area:** Used to read and write IC card data.
- ⑨ **Display Screen:** Show remote frequency or transponder ID.
- ⑩ **Remote Frequency Button:** Press this button to show remote frequency in the display screen.
 - ① When detecting remote frequency, please click the remote button of the key once so KC501 can receive the remote signal and report frequency.

- ⑪ **Transponder ID Button:** Press this button to show transponder ID in the display screen.
- ⑫ **Transponder Slot:** Holds the transponder to read or write transponder data.
- ⑬ **Vehicle Key Slot:** Used to hold the vehicle key to read or write vehicle key data.
- ⑭ **Remote Control Transponder Induction Area:** Used to read and write remote control transponder data.
- ⑮ **Mercedes Infrared Key Slot:** Used to read or write Mercedes vehicle key data.

TECHNICAL SPECIFICATIONS

Table 1-1 Specifications

Item	Description
OS	Android 5.1
Processor	Quad-core processor 1.8GHz
Ram	2G
Rom	64G
Display	9.7-inch capacitive, 1024×768 resolution
Connectivity	<ul style="list-style-type: none"> ● USB ● Wi-Fi ● Bluetooth
Camera	8-megapixel autofocus rear camera with flash
Sensor	Gravity sensor
Audio Input/ Audio Output	Microphone/ Loudspeaker
Ports	<ul style="list-style-type: none"> ● USB3.0 ● DC charging port ● VGA port ● DOIP port
Battery	10000mAh 3.7V lithium polymer battery
Input Voltage	12V DC
Operating Temperature	-10~50°C
Relative Humidity	< 90%
Dimensions	315.07×218.35×34.61 mm

2 GETTING STARTED

ACTIVATION GUIDE

When you turn on the system for the first time, the system will automatically enter the guide process and request the user to select the system operating language.

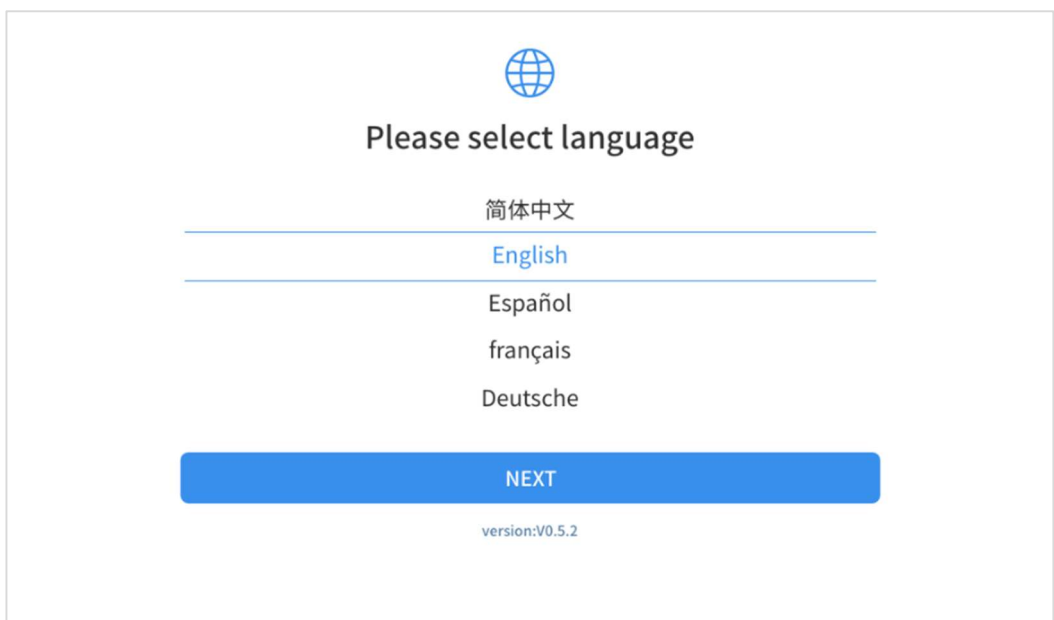

Fig 2-1

After selecting the system language, click **Next** to enter the Wi-Fi connection page, as shown below:

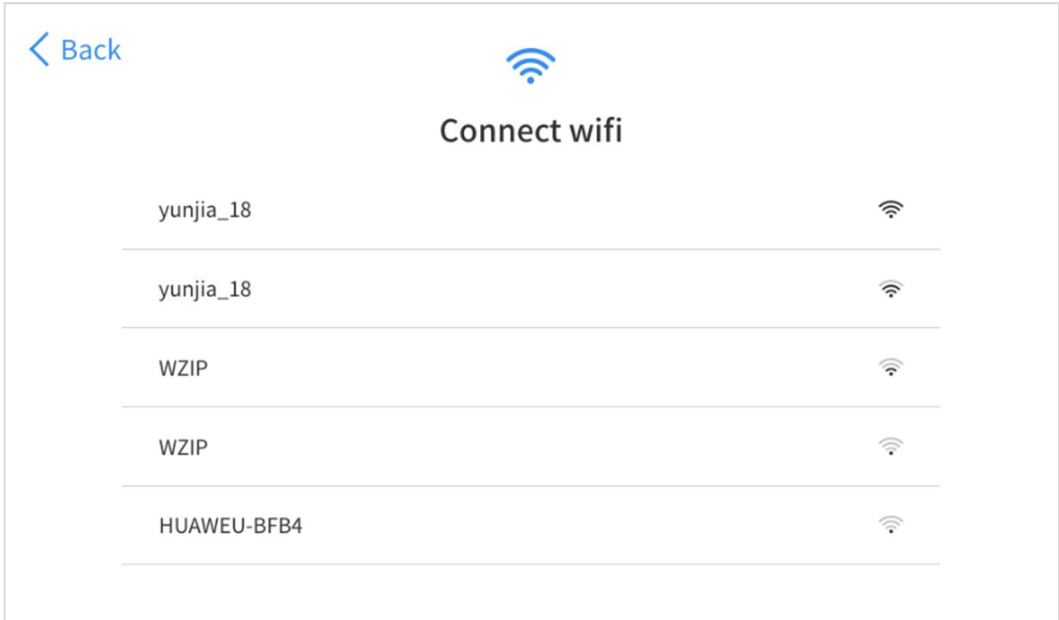

Fig 2-2

Select a network to connect to on the Wi-Fi connection page. After successful network connection, the automatic system will jump to **Factory mode** to download the software:

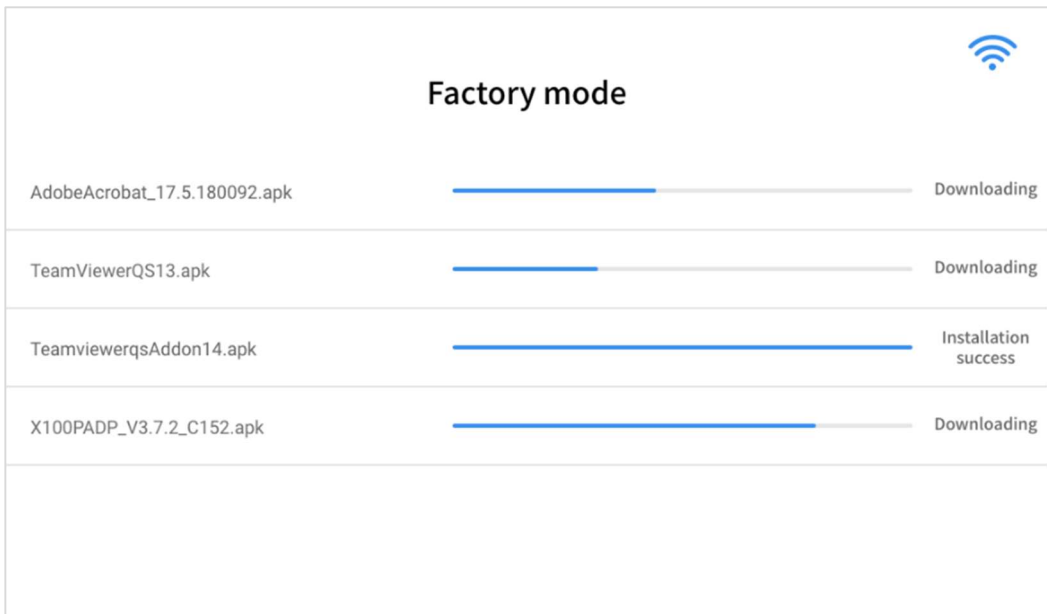

Fig 2-3

Once the software has been downloaded, the tablet will automatically reboot and request the system language selection again.

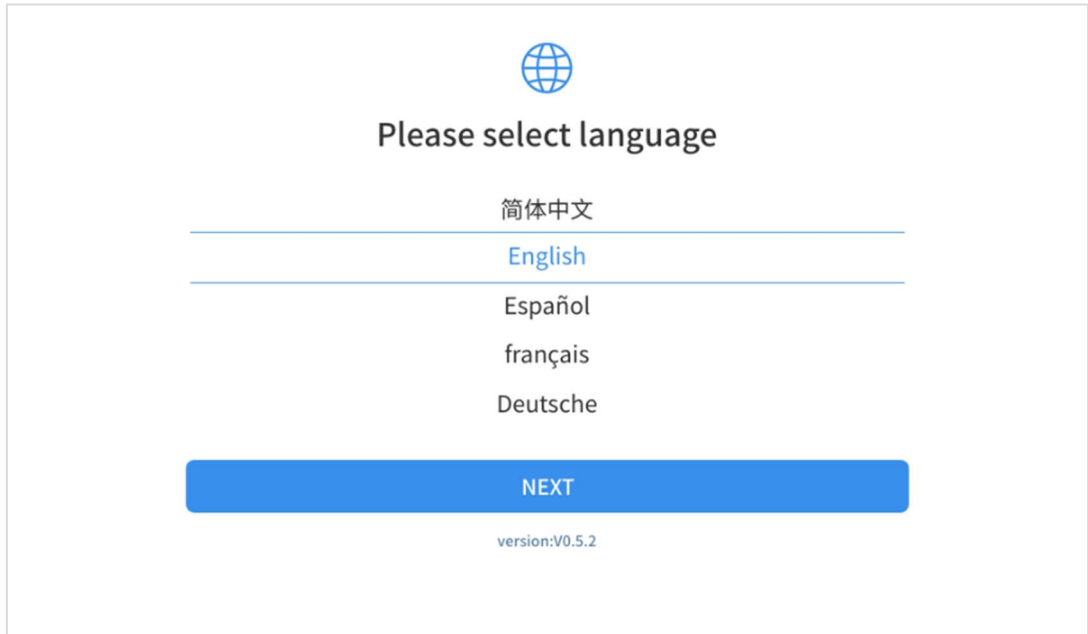

Fig 2-4

After setting the system language, you will enter the activation page, as shown in the figure below. You can also click the "Trial" button in the upper right corner to try it out before activation.

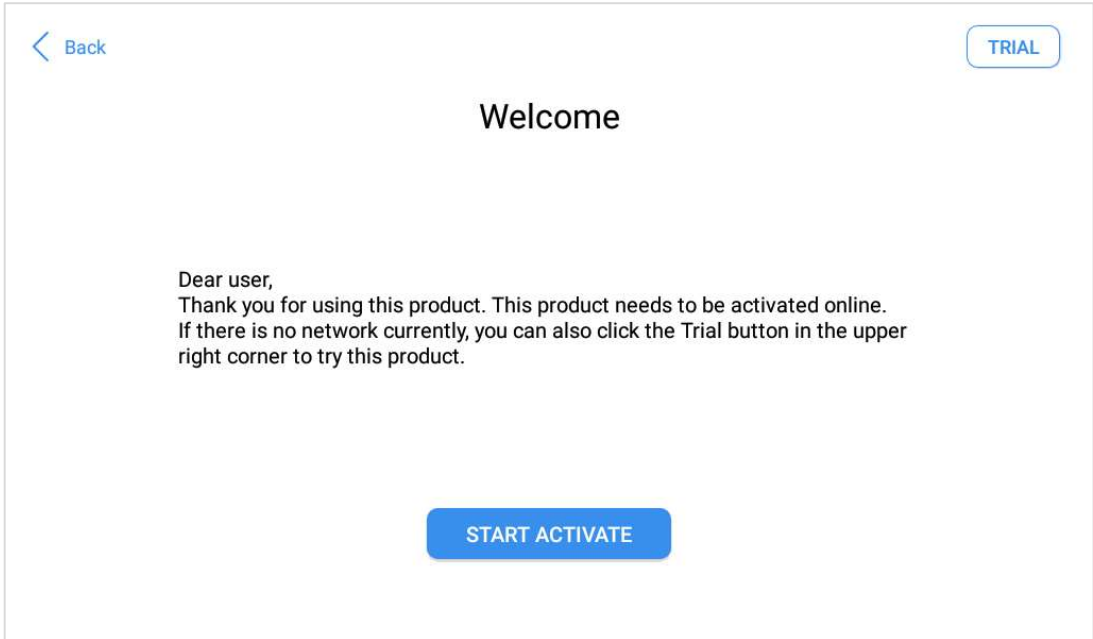

Fig 2-5

Click **Start Activate** to enter the activation page, as shown below:

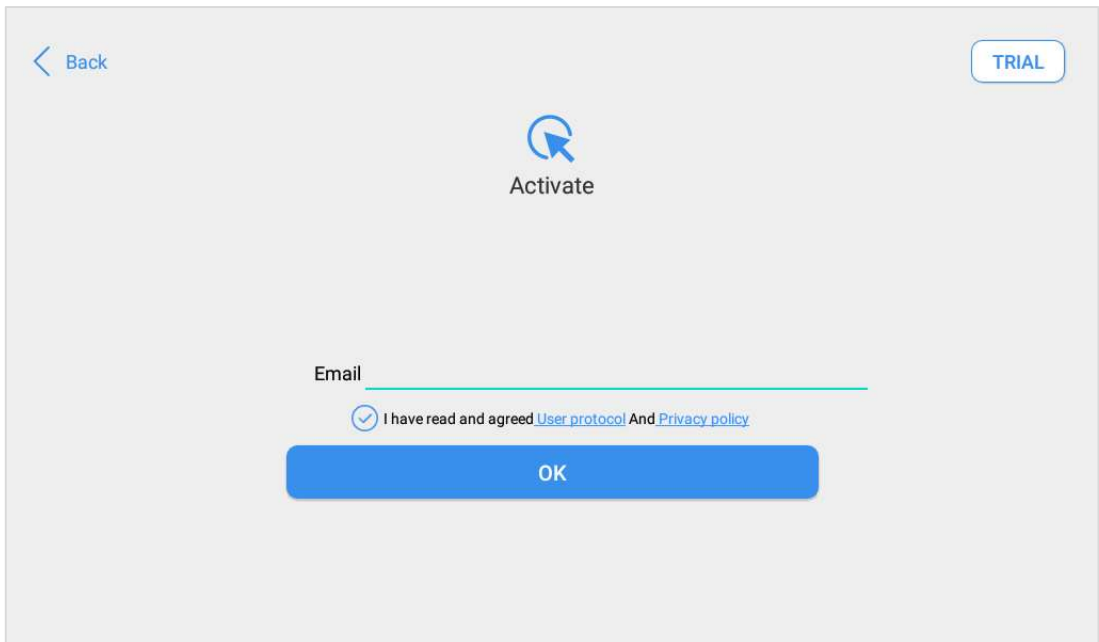

Fig 2-6

A pop-up window showing **Activation Success** indicates that you have completed the first boot setup, click **OK** to enter the diagnostic system and start using the device.

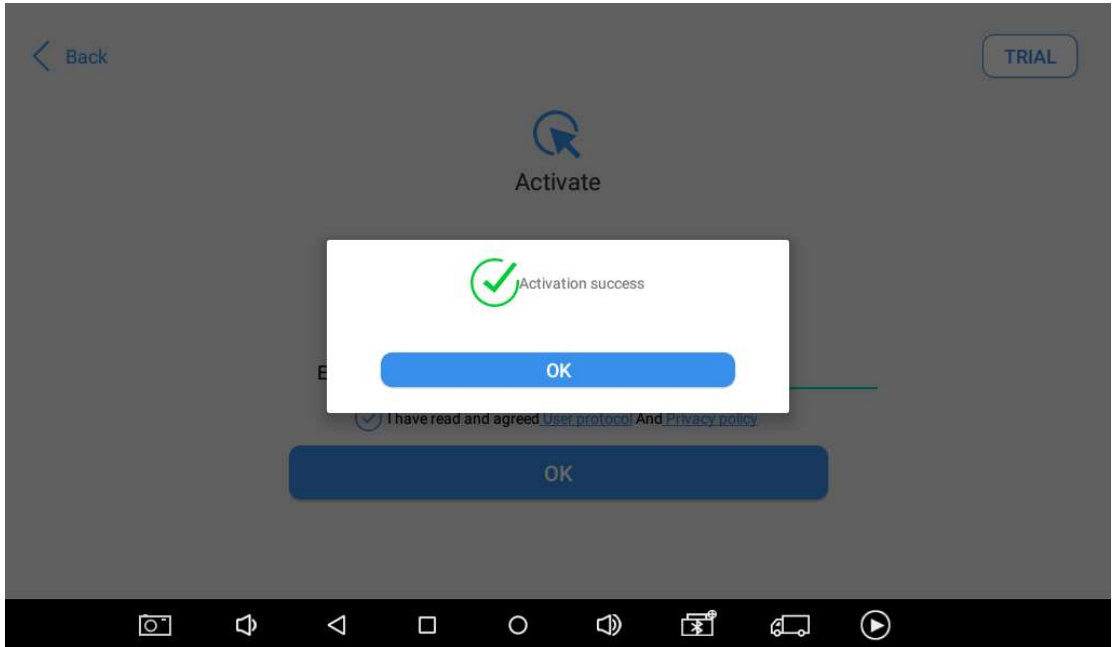



Fig 2-7

① If you meet problems like “Registration failed”, please check your network or contact Xtool aftersales services.

MAIN INTERFACE

OPERATION SYSTEM

The picture below (Fig 2-8) is the home screen of the operating system of the device. You can also return to this interface at any

time by clicking  on the bottom navigation bar.

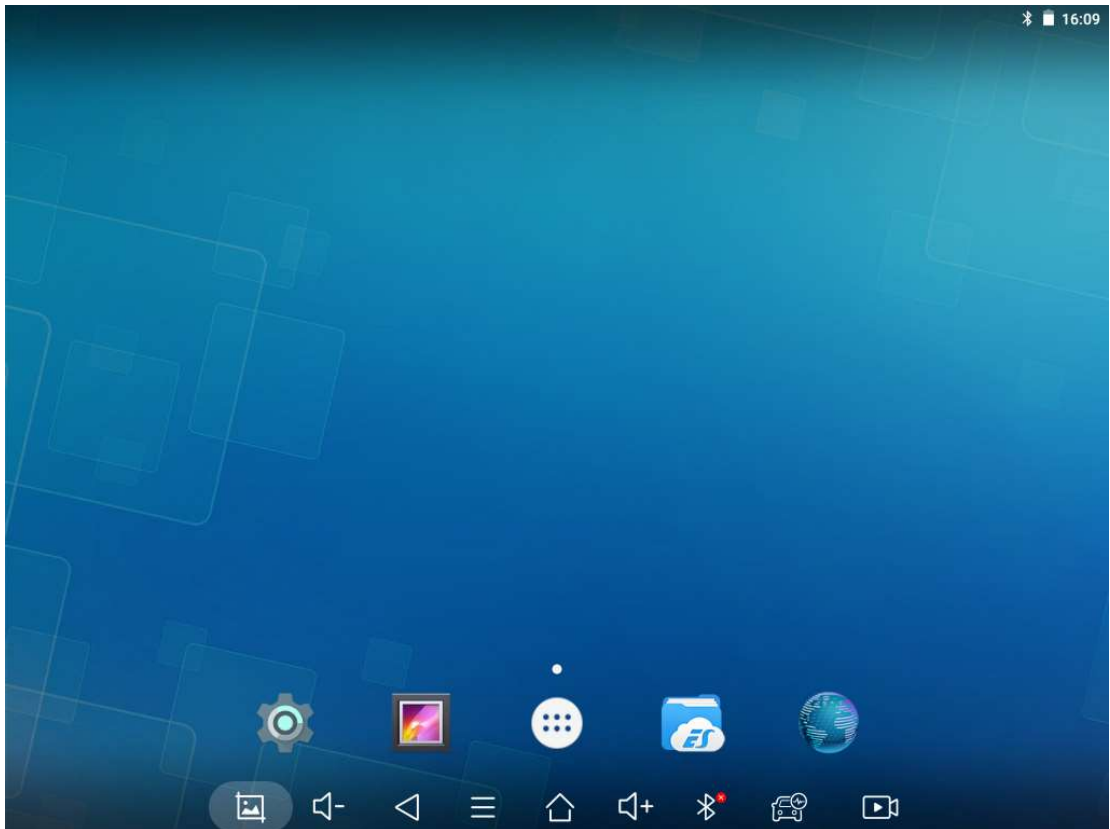

Fig 2-8

The app icons are as follows:

Table 2-1

Items	Descriptions
	Browser
	Gallery
	Application Menu
	ES File Explorer
	Android Settings
	X100MAX Key Programming System

- a) **Browser:** Click on the browser icon to enter the browser to view the official website of Xtool or search for other information.
- b) **Gallery:** Click the **Gallery** icon to enter the album and you can quickly view the pictures or screenshots stored in the device. You can select the picture you need, click the share button on the upper right, and send the picture to your mobile phone or PC via Bluetooth or USB connection
- c) **Application Menu:** Show all the apps that you have installed into the device. Also allows you to manage them.

d) **ES File Explorer:** You can manage APP, music, files, pictures, etc. in the device in this function, and you can also use Local/Home/Cleaner to clean up files.

① If you need to check the files inside X100MAX app (not recommended), please use the file explorer inside X100MAX app.

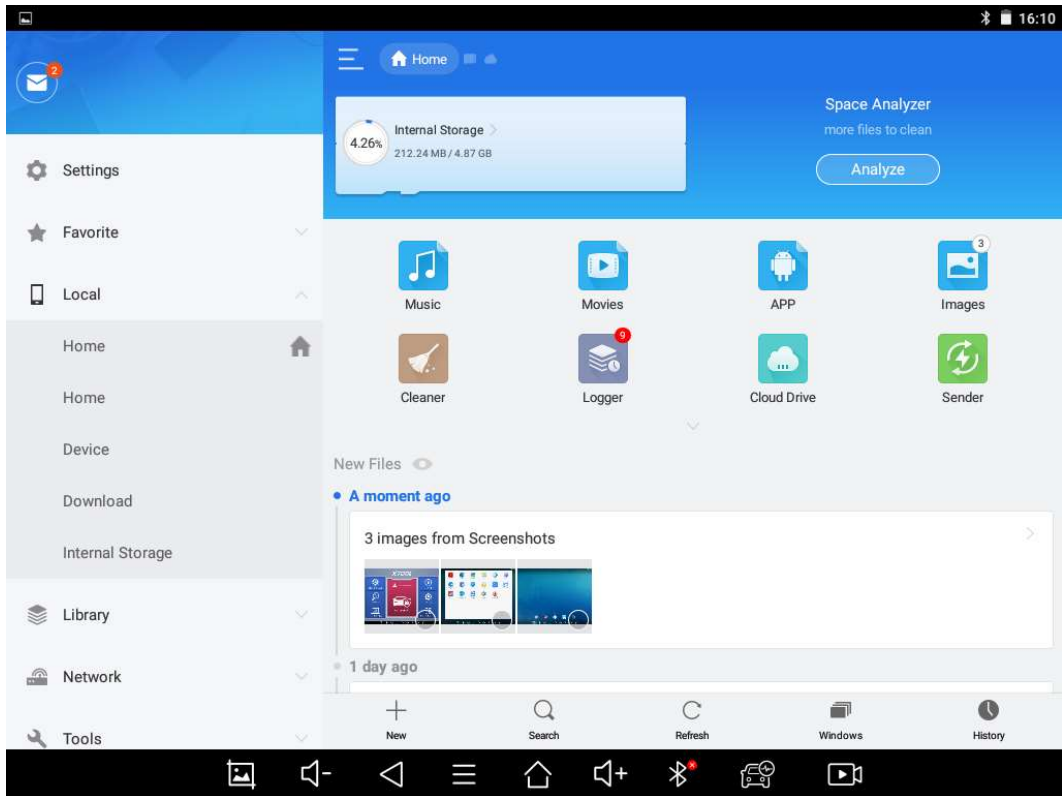

Fig 2-9

e) **Android Settings:** Allows you to check and change the settings of the Android system, including network, battery status, language, device info and factory reset.

f) **X100MAX Key Programming System:** This app provides all the key programming and diagnostic functions, and also offers a range of special maintenance services.

① It will be referred as “X100MAX app” later in this manual.

X100MAX APP MENU

Every time you start the tablet, you will automatically enter the X100MAX app with the following main screen. Tap on diagnosis application button on the menu, the main menu will be shown as below:







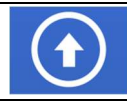



Fig 2-10

This main menu contains **Function Buttons** and **Navigation Buttons**. The touch screen navigation is made up by several menus, and you can quickly access functions by clicking on the icons. A detailed description of the menu structure can be found in the next section **Function Buttons**.

FUNCTION BUTTONS

The following table briefly describes each function button.









Table 2-2

Icon	Description
	Enter immobilizer menu
	Includes various special functions for vehicles
	Enter vehicle diagnosis menu
	Enter TeamViewer for remote support
	Update the immobilizer/diagnosis software through Internet
	Select the language and unit shown in the app, and check the Bluetooth status, device info and workshop info
	View extended functions like checking reports and check Xtool official website
	Check the diagnosis report that recorded in your device, print as PDF files, or share to other devices

NAVIGATION BUTTONS

Instructions for operating the navigation bar buttons at the bottom of the screen, as described in the table below:

Table 2-3

Items	Descriptions
	Back to previous screen
	Back to the main screen of Android system
	Shows recently used applications
	Press to screenshot
	Increase volume
	Click here to return to diagnostic vehicle models interface
	Decrease volume
	Check Bluetooth status (Red – disconnected/Green – connected)

NOTIFICATION BAR

Slide down to open the notification bar. You can adjust the brightness of the screen when you need, and you can also connect Wi-Fi and so on.

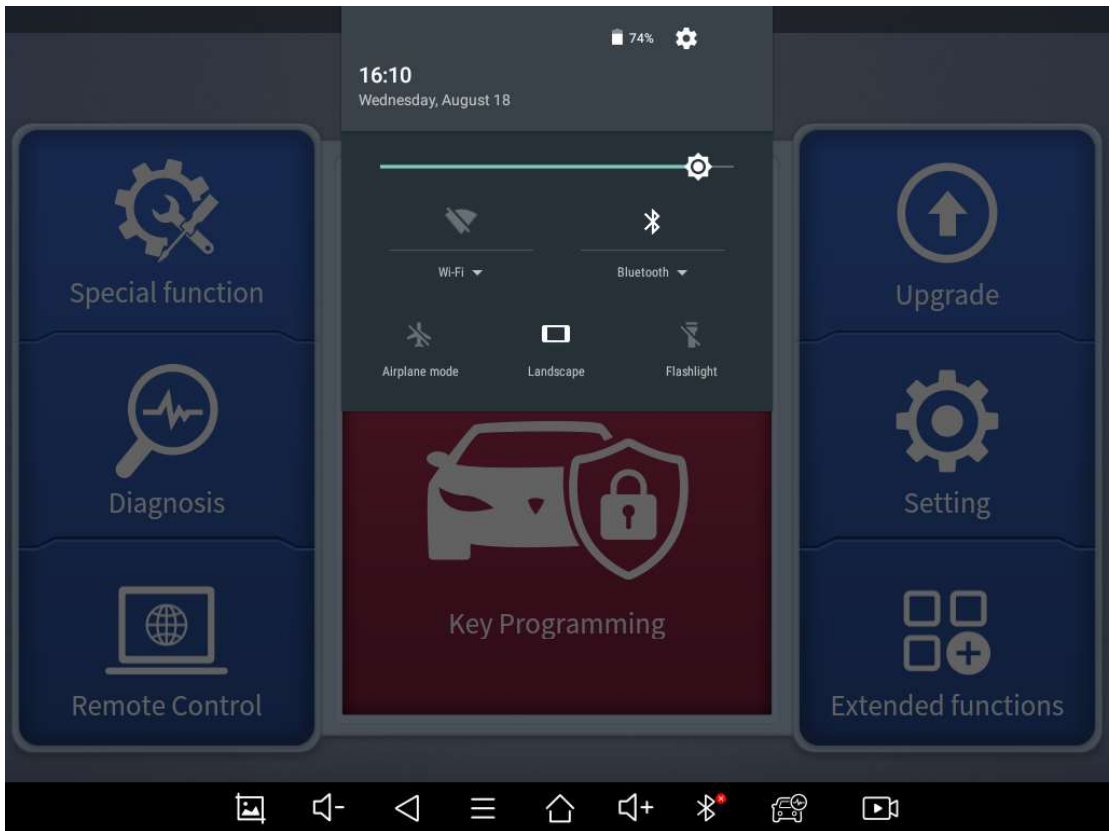

Fig 2-11

3 UPDATE

After activating the device, please update the software in **"Update"** first. The device will pull all currently supported software packages from our servers, and you can download them as needed. To access the update application, open the diagnosis application and click UPGRADE, and it will show as below:

① X100MAX has a two-year free subscription when activated. When you click "update" and it shows "your device is now out of subscription", please contact your dealer.

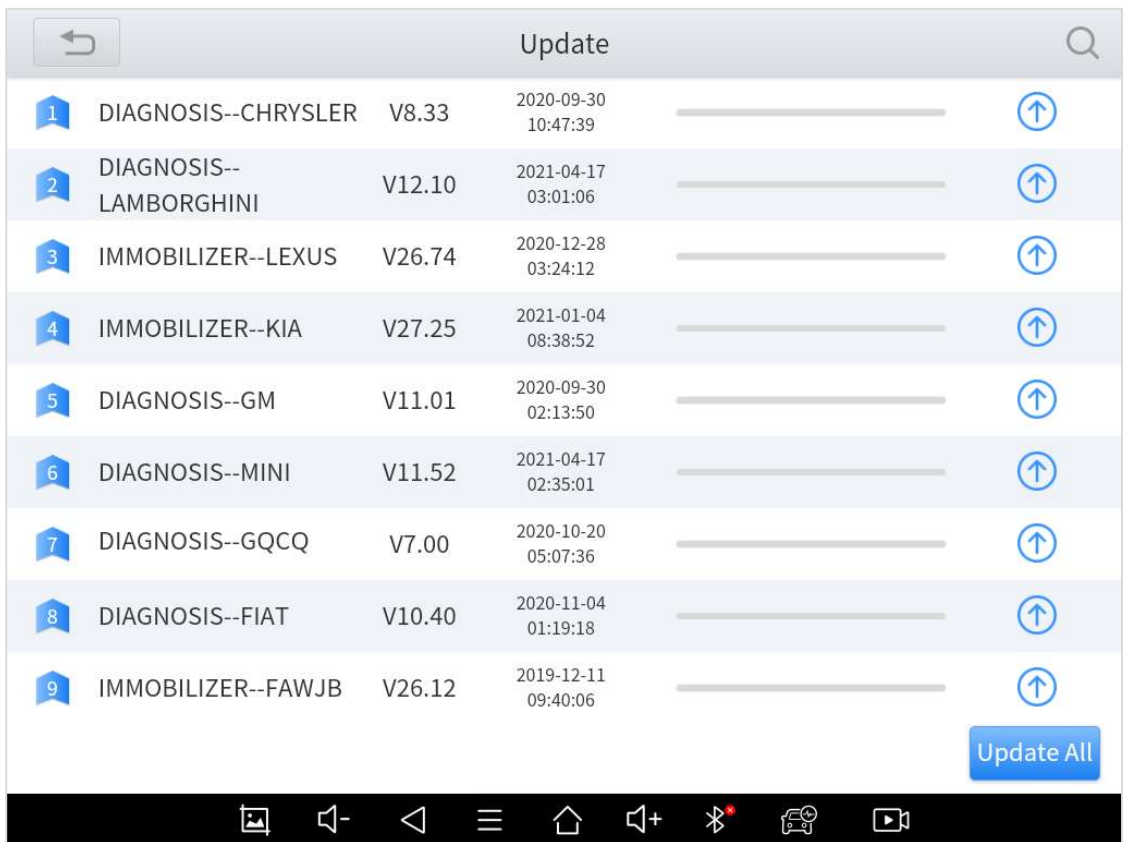

Fig 3-1

4 KEY PROGRAMMING

The key programming software inside X100MAX app can get access to the immobilizer system inside the vehicles and supports multiple functions like key programming, generate dealer key, all key lost, immobilizer reset or changing, EEPROM chip coding and much more.

① For different manufacturers, the menu inside each software and the supported functions will be different. We suggest checking the support list inside our official software first or ask XTOOL aftersales services if you have any questions.

VEHICLE CONNECTION

To start the key programming process, the VCI communication box should establish communication with the vehicle, and Bluetooth should be connected between the tablet and the VCI box. Please follow the steps below.

1. Turn on the tablet.
2. Connect the vehicle, the VCI box and the tablet following the diagram below. Usually, the OBD port is located under the dashboard, inside driver's footwell.
3. Wait for the VCI box to communicate with the tablet, then click into the menus to perform the functions.

① If necessary, please connect the VCI box with the tablet using the USB 3.0 to USB-B cable, especially when working on some processes that needs to transfer lots of data, like resetting the immobilizer ECU.

① Some older vehicles are not using the OBD2-16 port, please make sure you're using the correct connector. There are 4 extra connectors that's attached into X100MAX, but please contact your dealer if you need other connectors.

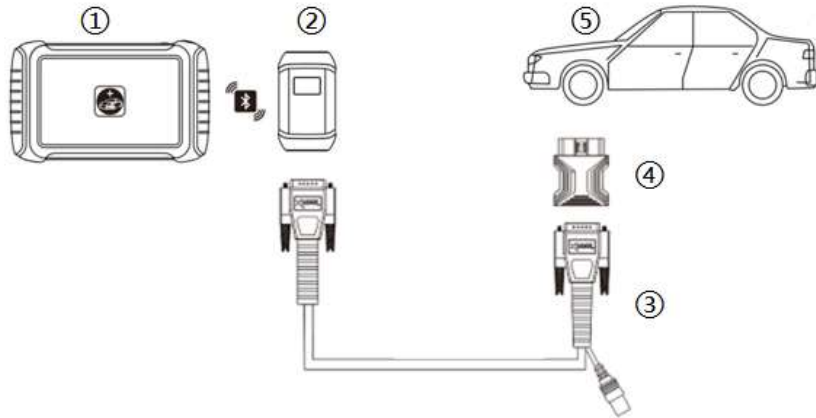

Fig 4-1

KC501 CONNECTION

KC501 could be connected to the tablet via USB-B to USB3.0 cable. If you need to connect KC501 to the tablet while programming, please check the diagram below.

① KC501 could also be connected to PC via USB. Please check XTOOL official website and download "KC501 Studio" to perform key programming, ECU/MCU & EEPROM modifying functions.

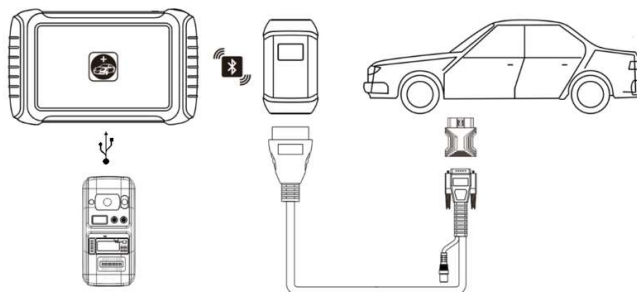

Fig 4-2

IMMOBILIZER MENU

Click “Key Programming” icon on the main screen and get into the immobilizer menu. Choose the brand of the vehicle to start the programming process. You can also click the search icon on the top-right corner of the screen and find the brand you need.

① For different models with different immobilizer modules, the key programming process will be completely different. Most of the process could be done by following the instructions on the screen. But if you are not sure how to do that, please check the tutorials.

① If you need to check if your car is supported, you can click the PDF icon at the top right of the model brand button.

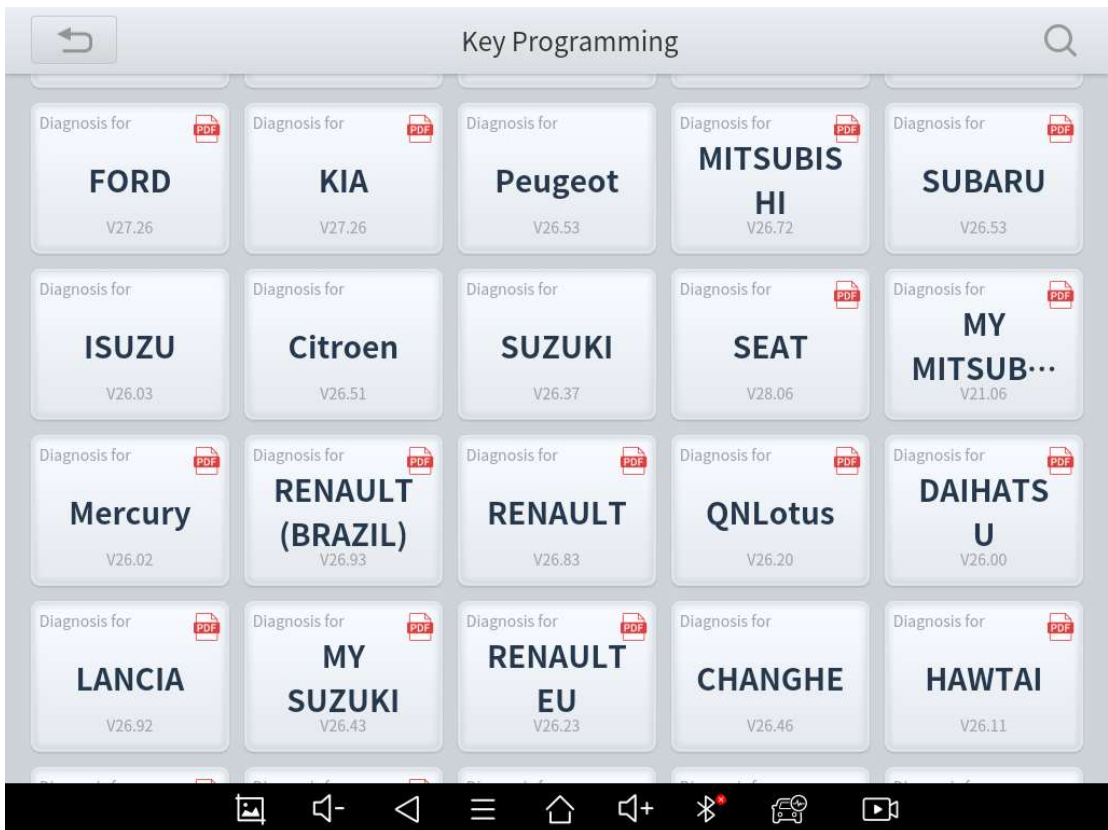

Fig 4-3 Immobilizer Menu

IMMOBILIZER FUNCTIONS

Normally the key programming software supports these functions:

- Check number of keys
- Read PIN code/pin code calculation
- Add key
- Generate dealer key
- All key lost

And more...

Some examples will be provided in this manual to help you understand the process.

① For different models with different immobilizer modules, the key programming process will be completely different. Because of that we can only give some examples about how to do that. Most of the process could be done by following the instructions on the screen. But if you are not sure how to do that, please check the tutorials.

READ PIN CODE/PIN CODE CALCULATION

Let's take Nissan/Infiniti software for example. Click "Key Programming – Nissan/Infiniti – Pin Calculator" to enter the system. After selecting the manufacturer (here we choose "General"), the menu below will show up.



Fig 4-4

Please choose the type of your vehicle. If you have any questions, please click “Help” for more details.

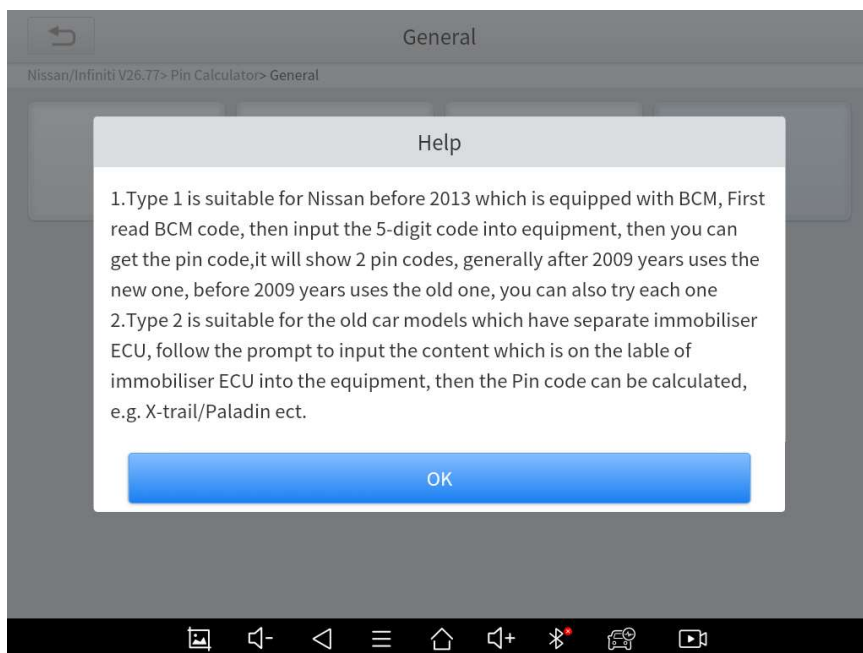

Fig 4-5

Here we choose “Type 1”, then insert the 5-digit BCM code.

① The BCM for Nissan vehicles may be found under the steering wheel, behind the glove box, behind the passenger/driver side kick panel and behind dash cluster - depending on the model of vehicle.

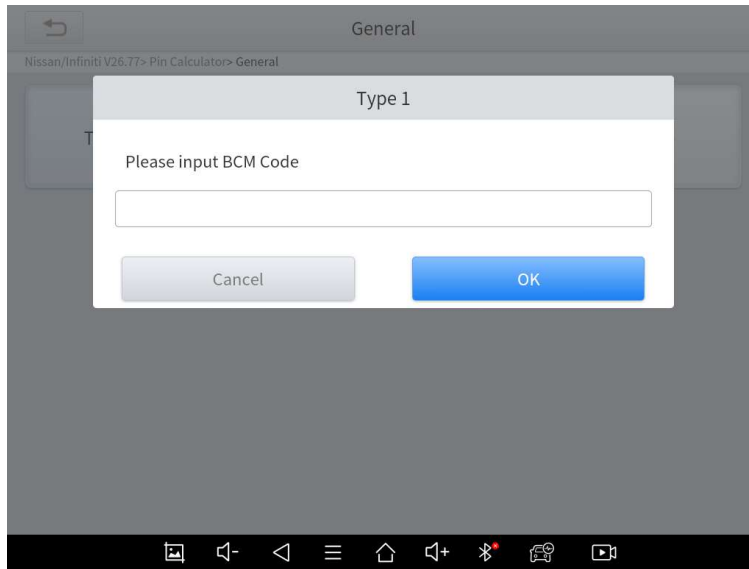

Fig 4-6

After you inserted the code, the results will show up.

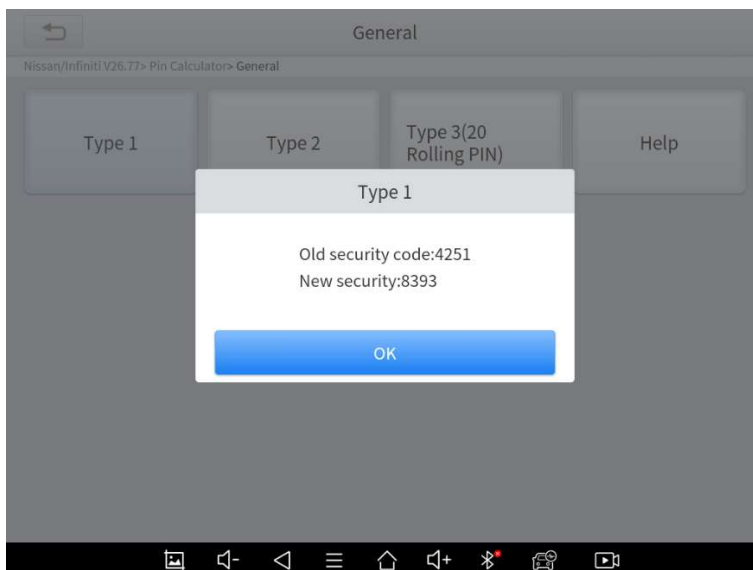

Fig 4-7

① Quick Tip: If you have trouble working on Nissans, please change the language into English, check the updates and see if there is a “NISSAN PIN DATA”. Usually download it will solve the problem.

CHECK NUMBER OF KEYS

Here we take a 2007 Ford Focus with mechanical key as an example. Click “Key Programming – Ford – North American Ford – Focus – 2005-2007” to enter the system.



Fig 4-8

Click “Number of keys” and it will show the number of the keys that are registered to the vehicle.

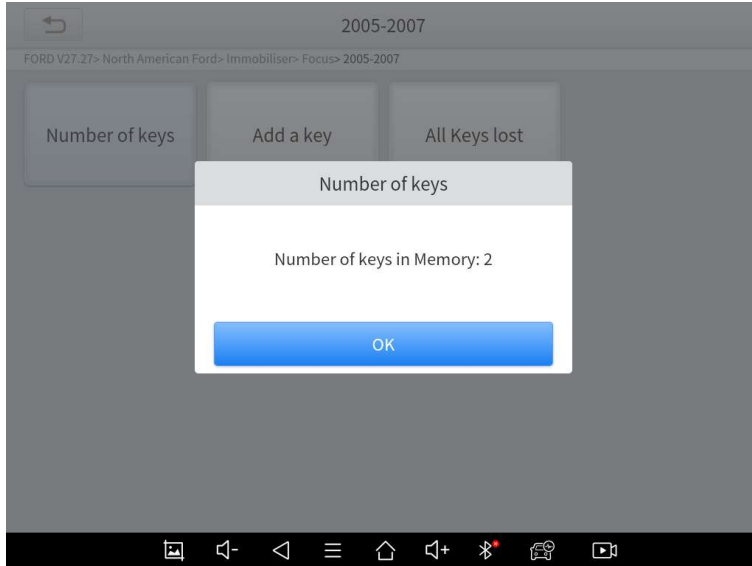

Fig 4-9

ADD KEYS

Still take the 2007 Ford Focus as an example. Click “Add key” menu, then follow the instruction on the screen. Take a new key, insert it into ignition, and switch ignition ON.

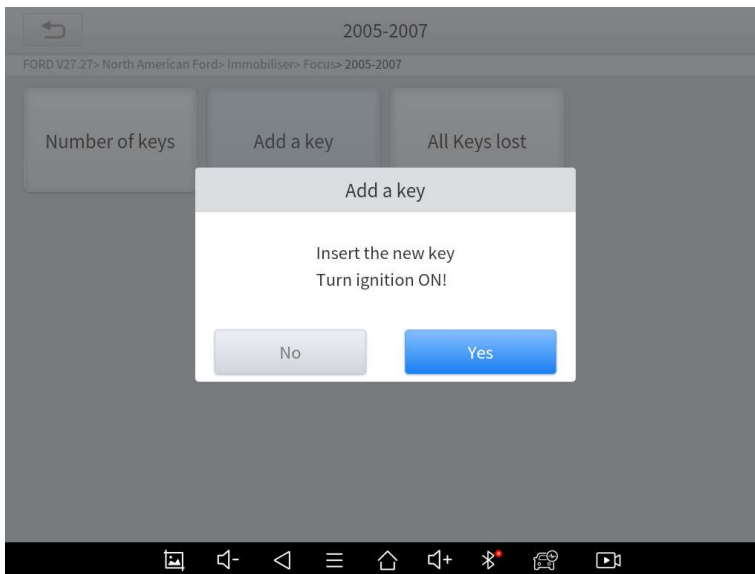

Fig 4-10

You can choose “Free-wait mode” to bypass the security access, or you’ll need to wait for about 10 minutes. We choose “Yes” here.

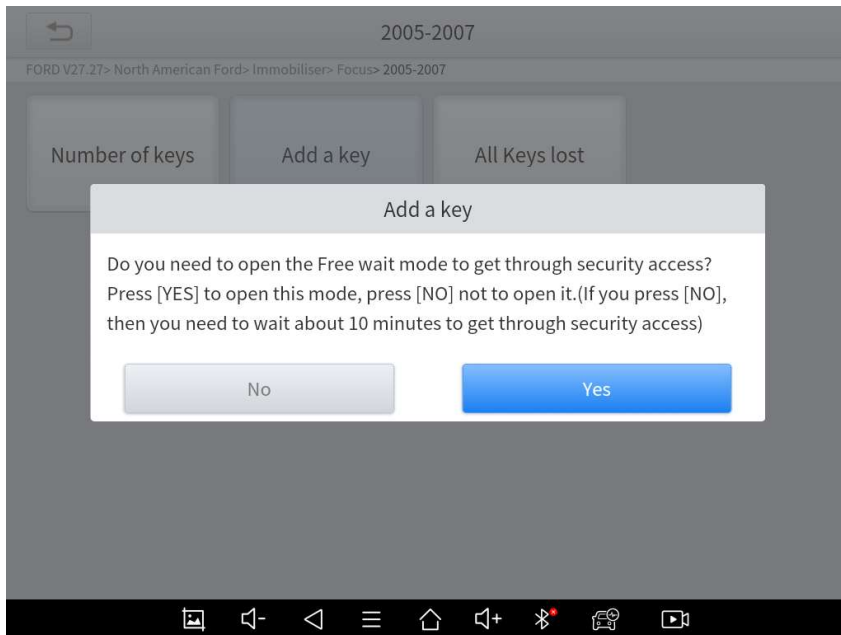

Fig 4-11

Wait for a while until it shows the results.

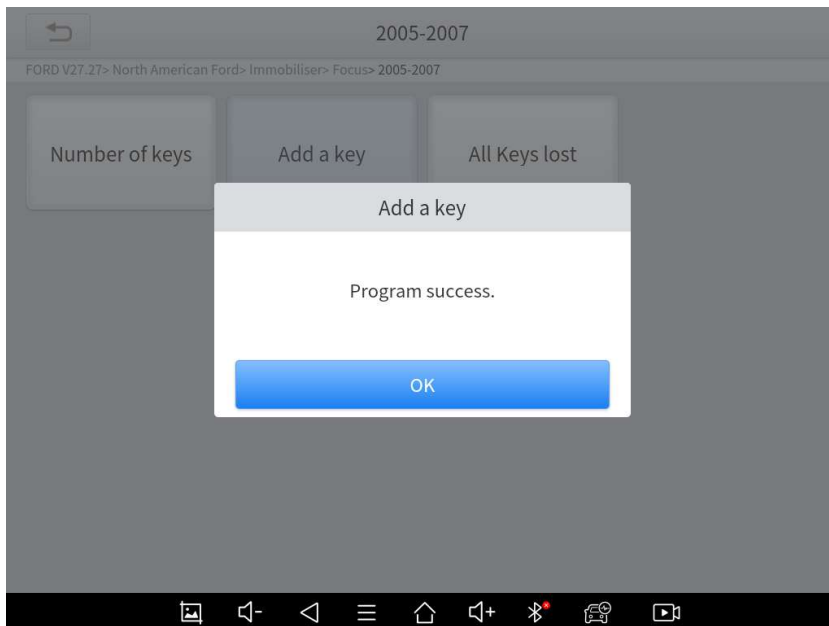

Fig 4-12

ALL KEY LOST

Still take the 2007 Ford Focus as an example. Click “All keys lost” menu and this notice will show up. Since this is an all-key-lost situation and we need to clear all the registered key, choose “Yes” here.

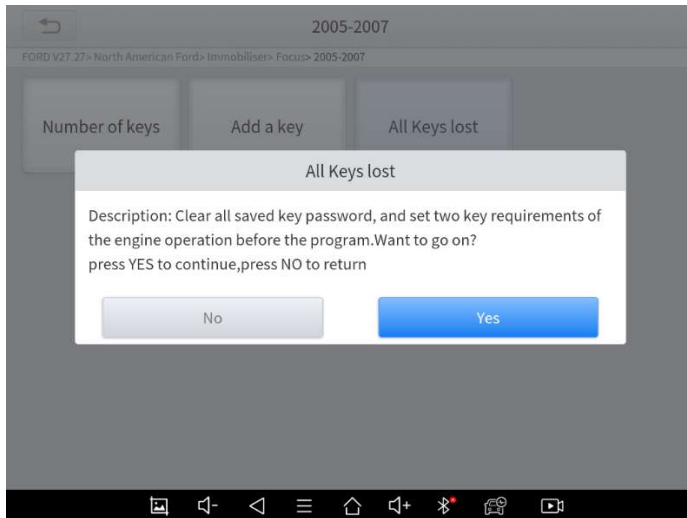

Fig 4-13

This also has a “Free-wait mode”, click “Yes” here.

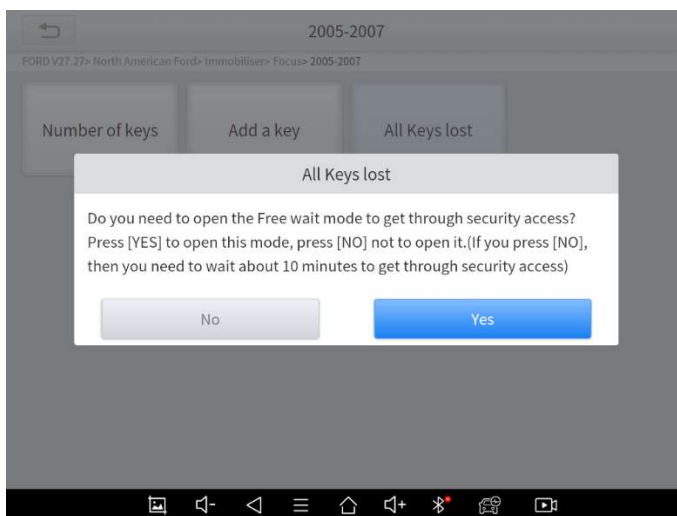

Fig 4-14

Wait a while until the results shows up.

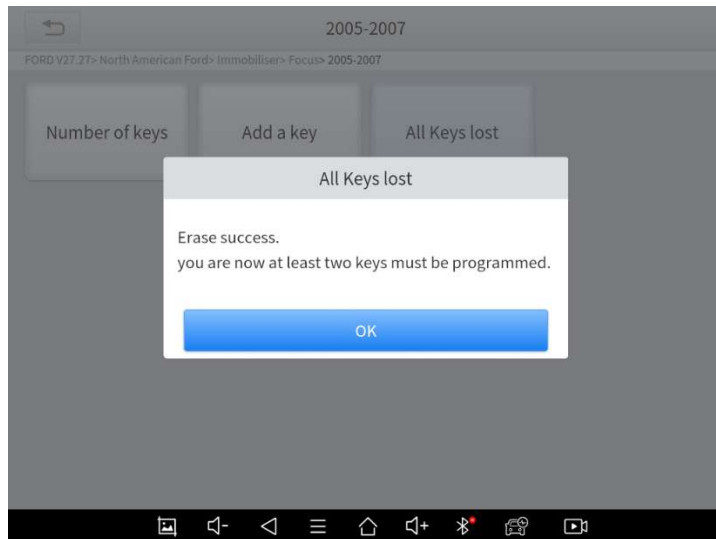

Fig 4-15

After successfully reset, please insert two new keys into the ignition switch and turn them on one by one.

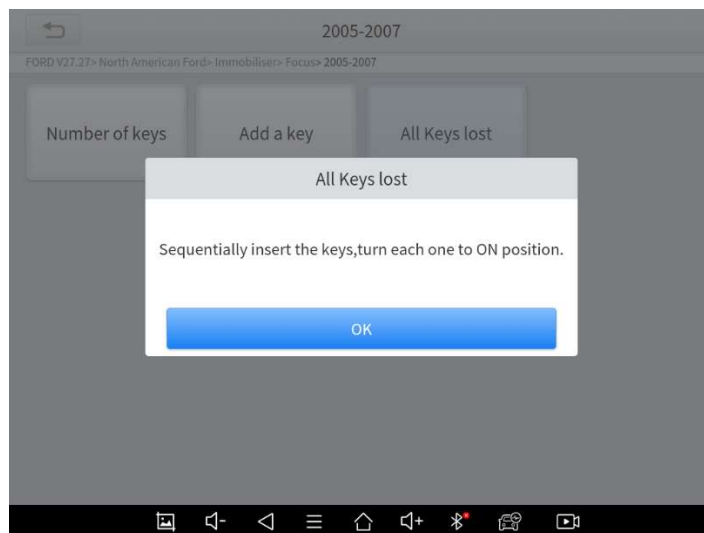

Fig 4-16

① We suggest checking all the keys every time after you programmed the key.

5 DIAGNOSIS

The diagnostic application can read ECU information, read and clear DTC and check live data and freeze frames. The diagnosis application can access the electronic control unit (ECU) of various vehicle control systems, including the engine, transmission, anti-lock braking system (ABS), airbag system (SRS), and perform kinds of actuation tests.

VEHICLE SELECTION

Click “Diagnosis” icon on the main screen and get into the diagnosis menu. Like the immobilizer menu, the brands will be shown on the screen. Select the region of your vehicle, click the correct brand, and start diagnosis process.

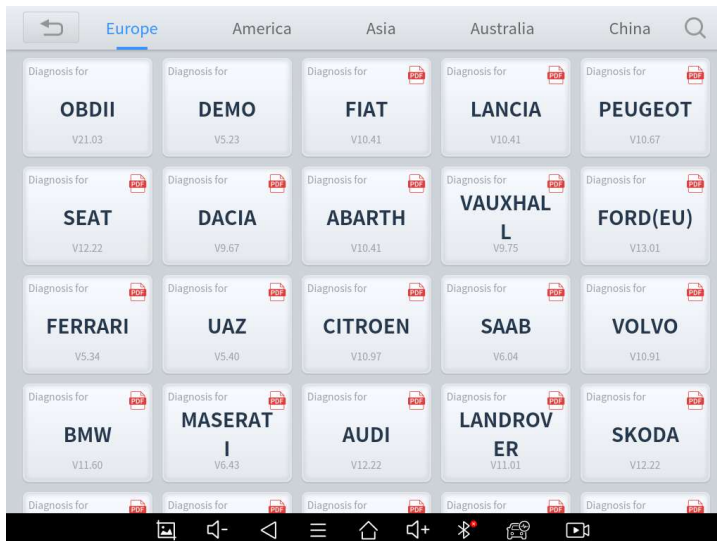

Fig 5-1

For some of the brands (like Volkswagen), when you click in the software, there are several ways to select the model or system you want to run a diagnosis, including **Automatic Detection**, **Manual Selection** and **System Selection**.



Fig 5-2

Automatic Detection will automatically identify the vehicle's VIN code, and then read the information of your target diagnostic object. If you choose "**Manual selection**", then you can continue to select the vehicle brand, year, and model of the vehicle in the sub-menu to diagnosis the vehicle. Enter "**System Selection**", you can also diagnose the vehicle according to the system according to your needs after selecting the model.

① OBDII menu supports reading the common fault codes in the engine. The DTCs may not be the same when comparing with using common diagnosis software.

① DEMO is a demonstration program. You can perform basic diagnosis functions without connecting to the car.

DIAGNOSE FUNCTIONS

The diagnosis system supports 5 basic diagnosis functions:

- **Read ECU Information**
- **Read/Clear Trouble Code**
- **Read Live Data**
- **Actuation Test (Bi-Directional Control)**
- **Freeze Frame**

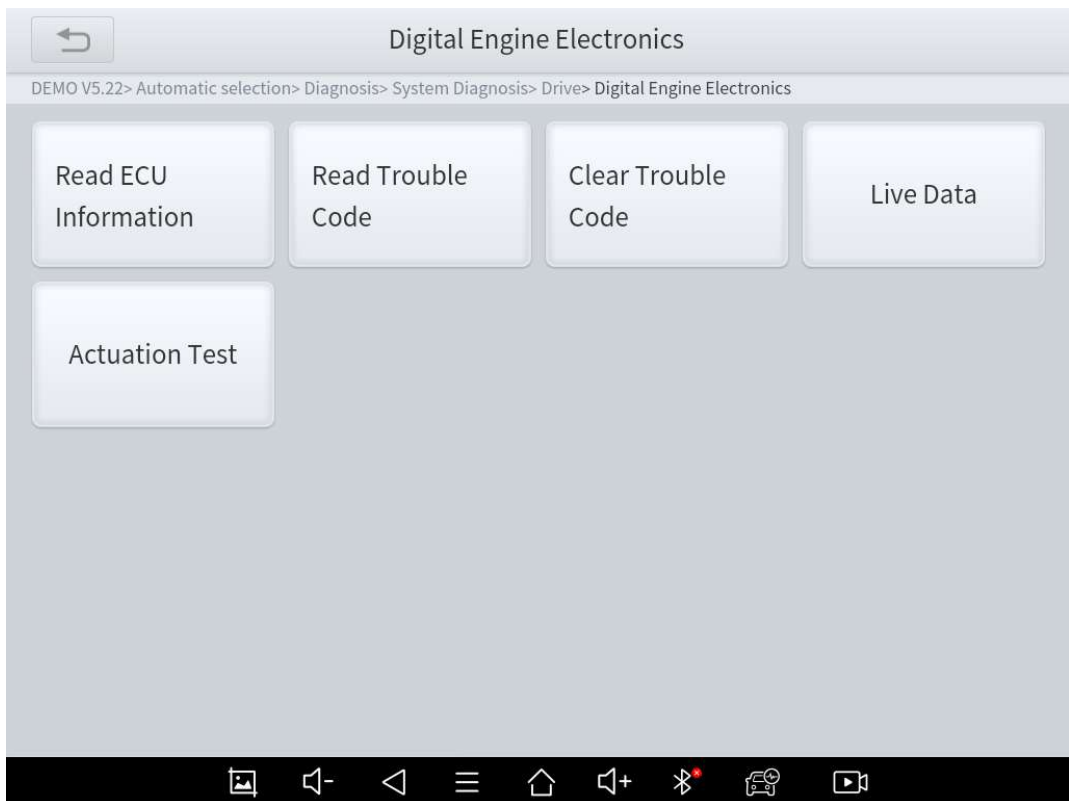

Fig 5-3

■ Read ECU Information

This function is to read ECU version information, which is the equivalent of "**System Identification**" or "**System information**" in some electronic control systems, which means to read ECU related software and hardware versions, models and production date of diesel engine, part number, etc.

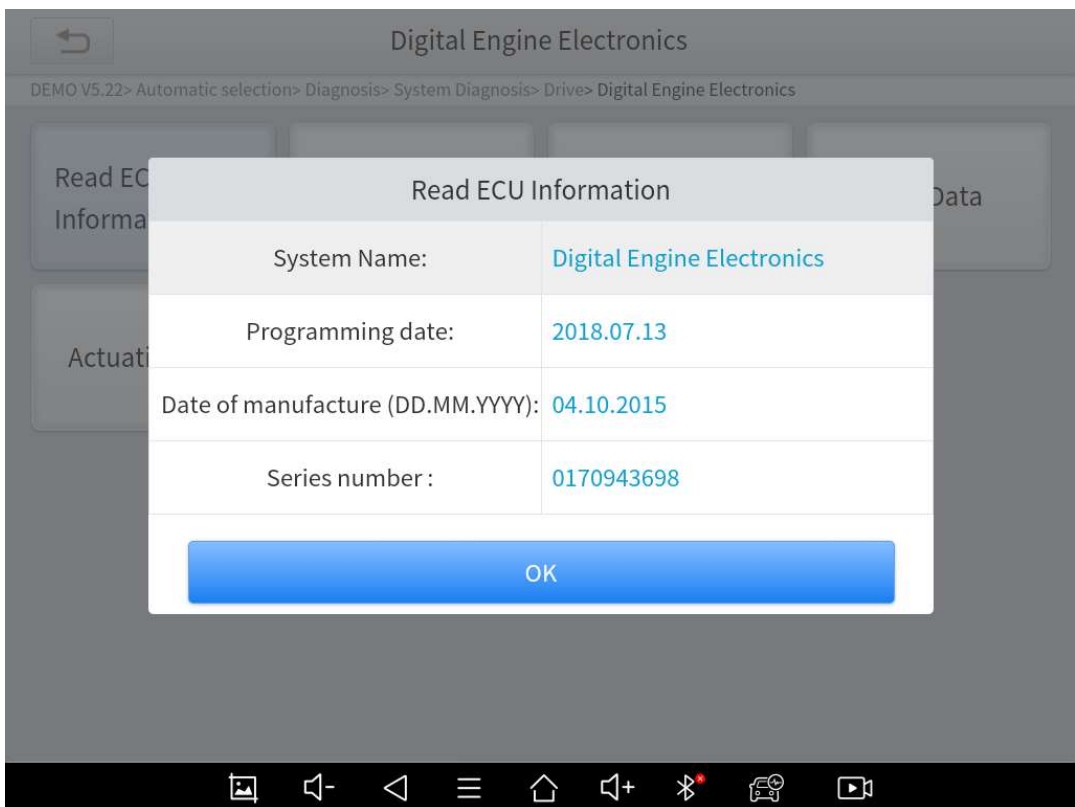

Fig 5-4

■ Read Trouble Code

Read trouble codes that's stored in ECU.

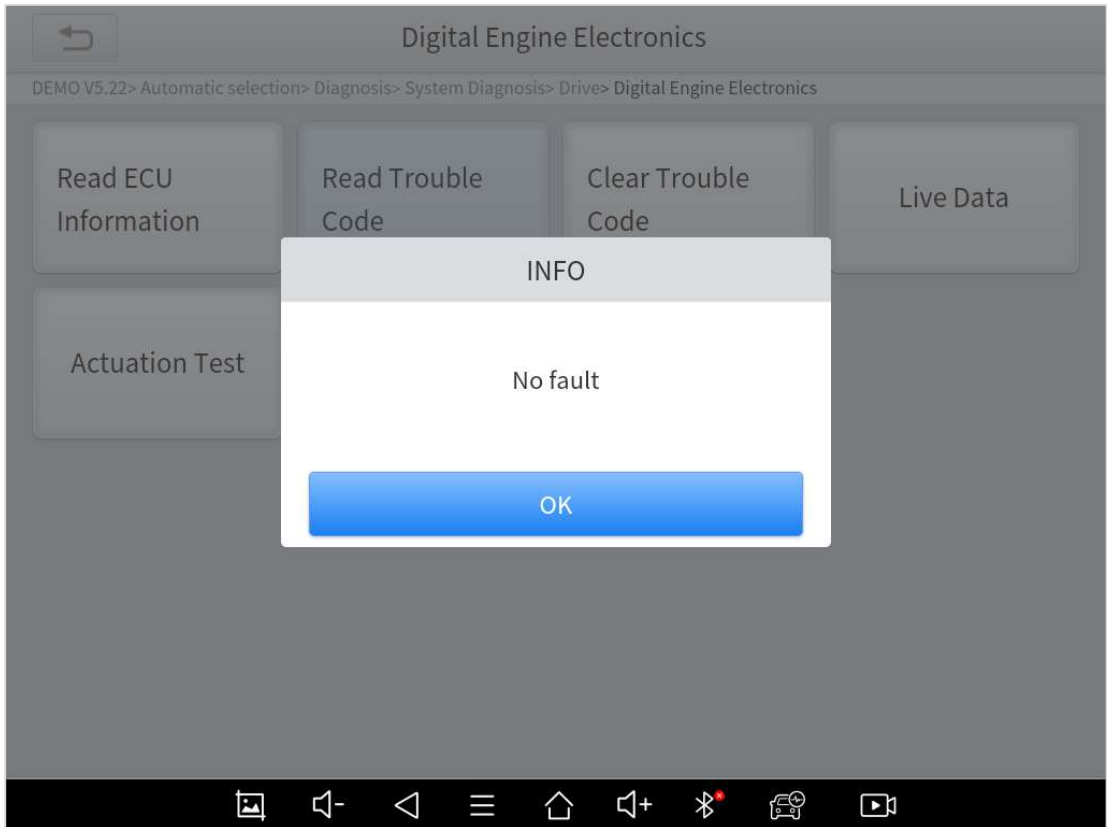

Fig 5-5

① In the process of diagnosis, if the device shows “System is OK” or “No Trouble Code”, it means there is no related trouble code stored in ECU or some troubles are not under the control of ECU, most of these troubles are mechanical system troubles or executive circuit troubles, it is also possible that signal of the sensor may bias within limits, which can be judged in Live Data.

■ Clear Trouble Code

It allows to clear current and historical trouble codes memory in ECU, under the premise that all the troubles are eliminated.

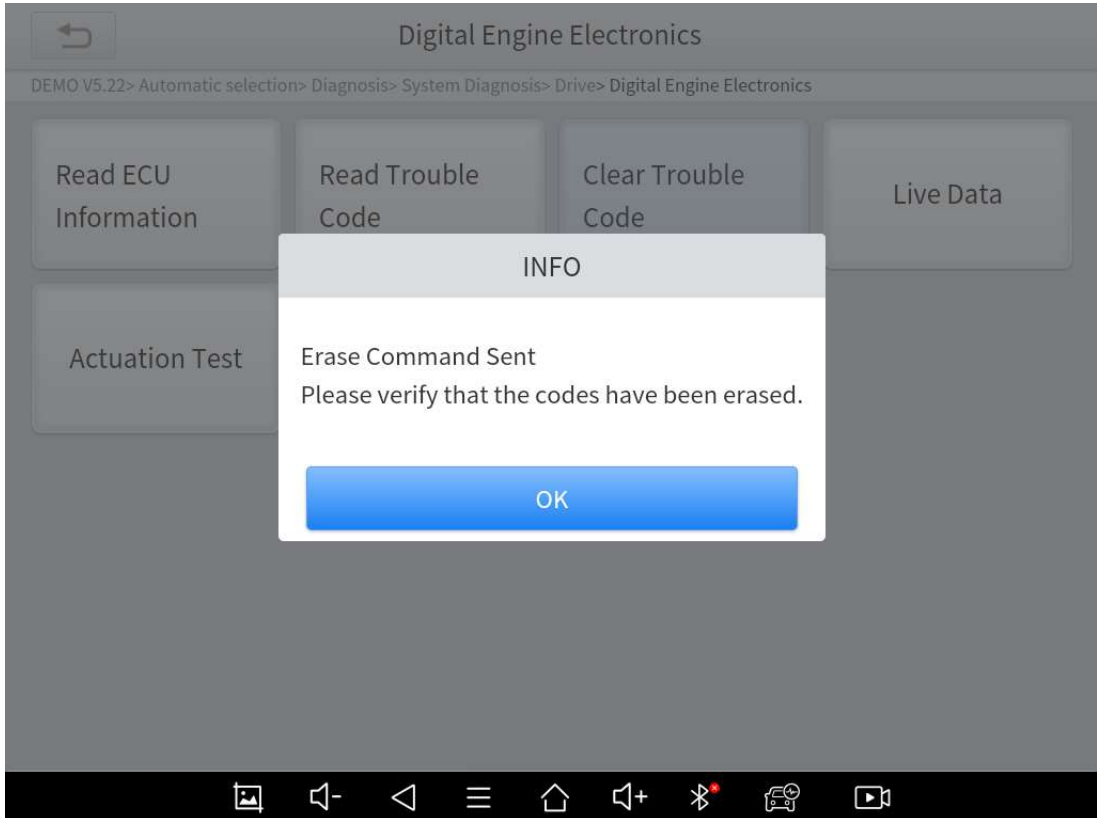

Fig 5-6

① The trouble codes can't be erased without eliminating all the troubles, which will cause the diagnostic tool always reading the trouble code because the code will always be saved in ECU.

■ Read Live Data

That is to read the parameters of the system, like for engine diagnosis, there are parameters like oil pressure, temperature, engine speed, fuel oil temperature, coolant temperature, intake air temperature, etc. Based on these parameters, we can judge directly

where the problem lies, which helps to narrow the scope in maintenance. For some vehicles, during their actual operation, the problems such as performance characteristics offset, sensitivity reduction, can be judged in live data.

Diagnosis request			
DEMO V5.22> Automatic selection> Diagnosis> System Diagnosis> Drive> Digital Engine Electronics> Live Data			
NO.	Name	Value	Unit
1	Engine speed	44.00	1/min
2	Coolant temperature	-48.00	degree C
3	Engine oil temperature	49083.75	degree C
4	Emissions warning light: Status	2	
5	Emissions warning light: Distance travelled since activation	N/A	km
6	Status, engine warning light	255	
7	Operating time since engine start	250.30	s
8	Operating hour counter	5160.00	min

Data Playback Pause Graph

Fig 5-7

■ Actuation Test

Actuation test, also known bidirectional control, is a generic term used to describe sending and receiving information between one device and another.



Fig 5-8

The vehicle engineers responsible for designing computer control systems programmed them so a scan tool could request information or command a module to perform specific tests and functions. Some manufacturers refer to bidirectional controls as functional tests, actuator tests, inspection tests, system tests or the like. Reinitialization and reprogramming also can be included in the list of bidirectional controls.

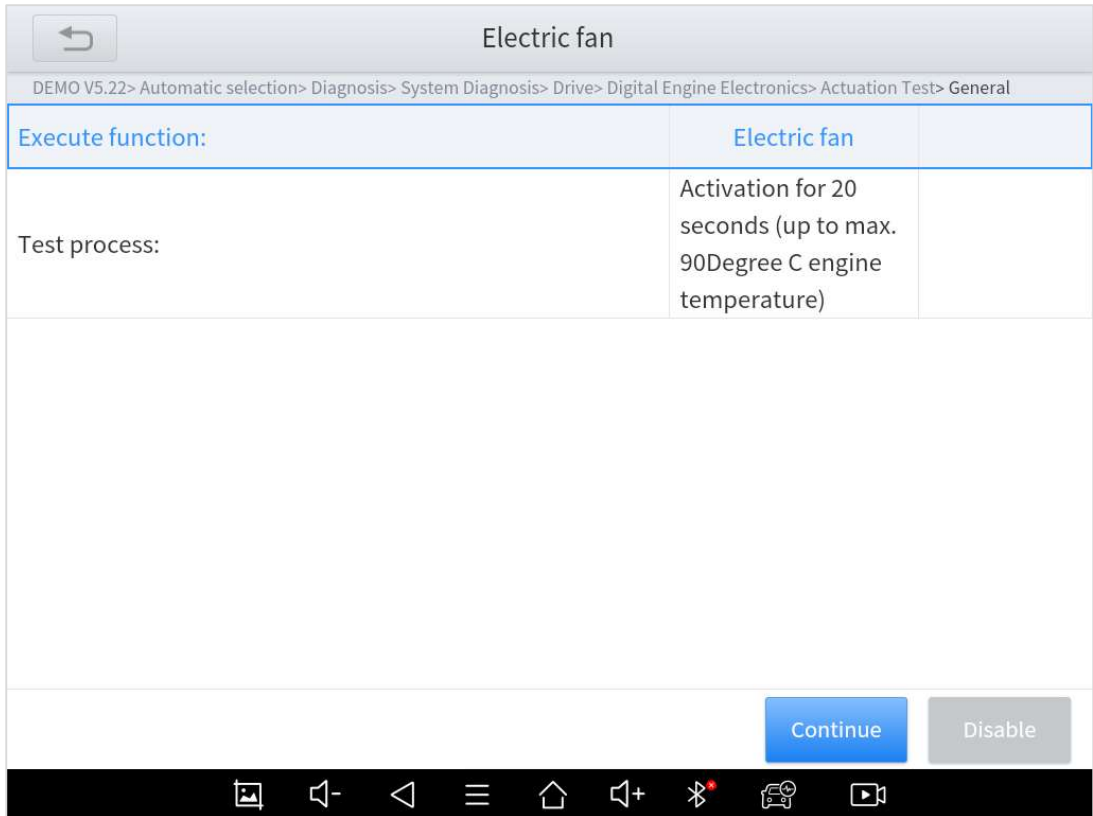

Fig 5-9

This function allow device sends information to, and receives information from, vehicle control modules. For example, in the case of OBD II generic information Mode 1 (which relates to data parameters), the scan tool user initiates a request for information from the powertrain control module (PCM), and the PCM responds by sending the information back to the scan tool for display. Most enhanced scan tools also have the ability to actuate relays, injectors and coils, perform system tests, etc. Users could check the individual part to see what is working properly by actuation test.

■ Freeze Frame

When the signal of the sensor is abnormal, the ECU will save the data at that moment of failure to form a freeze frame. It is usually used to analyze the reasons that may lead to car failures.

The living data items supported by vehicles of different brands are not exactly the same, so the freeze frames displayed when diagnosing vehicle of different brands may also be different. Some vehicles may not have the option of freeze frame, because the model does not support this function.

6 SPECIAL FUNCTIONS

X100MAX Auto Key Programmer also supports 23 commonly used special reset functions, allowing you to quickly access your vehicle system for various scheduled services, maintenance and reset performance, eliminating the need to reset after resolving common problems. This user manual lists some of the commonly used special reset services for your reference. The special functions interface is shown as below:



Fig 6-1

- ① Due to the limitation of screenshots, the special functions shown in this picture are not complete.
- ① All special functions supported by X100MAX are subject to the actual special functions displayed on the device.
- ① Please make sure the vehicle you're working on supports the original functions.

OIL LIGHT RESET

Reset the Engine Oil Life System, which calculates the optimum oil life change interval based on the vehicle's driving conditions and climate. The oil life reminder must be reset each time the oil is

changed so that the system can calculate when the next oil change is required.

This function allows you to perform reset for the engine oil life system, which calculates an optimal oil life change interval depending on the vehicle driving conditions and climate.

This function can be performed in the following cases:

- If the service lamp is on, you must provide service for the car. After service, you need to reset the driving mileage or driving time so that the service lamp turns off and the system enables the new service cycle.
- After changing engine oil or electric appliances that monitor oil life, you need to reset the service lamp.

EPB

Electronic Parking Brake (EPB) System reset is a popular special function. You can use this function to reset the electronic parking brake system and brake pads, which also supports the brake pad replacement (retraction, release of the brake pump), G-sensor and body angle calibration. This function has multiple uses and can safely and effectively maintain the electronic brake system. These applications include deactivating and activating brake control systems, assisting in controlling brake fluid, opening and closing

brake pads, and setting brakes after replacing brake discs or brake pads, etc.

1. If the brake pad wears the brake pad sense line, the brake pad sense line sends a signal sense line to the on-board tablet to replace the brake pad.

After replacing the brake pad, you must reset the brake pad. Otherwise, the car alarms.

2. Reset must be performed in the following cases:

- The brake pad and brake pad wear sensor are replaced.
- The brake pad indicator lamp is on.
- The brake pad sensor circuit is short, which is recovered.
- The servo motor is replaced.

SAS

Steering Angle Sensors (SAS) System Calibration permanently stores the current steering wheel position as the straight-ahead position in the SAS EEPROM. Therefore, the front wheels and the steering wheel must be set exactly to the straight-ahead position before calibration. In addition, the VIN is also read from the instrument cluster and stored permanently in the SAS EEPROM. On successful completion of calibration, the SAS fault memory is automatically cleared.

To reset the steering angle, first find the relative zero-point position for the car to drive in straight line. Taking this position as reference, the ECU can calculate the accurate angle for left and right steering. After replacing the steering angle position sensor, replacing steering mechanical parts (such as steering gearbox, steering column, end tie rod, steering knuckle), performing four-wheel alignment, or recovering car body, you must reset the steering angle.

DPF

The Diesel Particle Filter (DPF) function manages DPF regeneration, DPF component replacement teach-in and DPF teach-in after replacing the engine control unit.

The ECM monitors driving style and selects a suitable time to employ regeneration. Cars driven a lot at idling speed and low load will attempt to regenerate earlier than cars driven more with higher load and speed. For regeneration to take place, a prolonged high exhaust temperature must be obtained.

In the event of the car being driven in such a way that regeneration is not possible, i.e., frequent short journeys, a diagnostic trouble code will eventually be registered in addition to the DPF light and “Check Engine” indicators displaying. A service regeneration can be requested in the workshop using the diagnostic tool.

DPF regeneration is used to clear PM (Particulate Matter) from the DPF filter through continuous combustion oxidation mode (such as high temperature heating combustion, fuel additive or catalyst reduce PM ignition combustion) to stabilize the filter performance.

DPF regeneration may be performed in the following cases:

- The exhaust back pressure sensor is replaced.
- The PM trap is removed or replaced.
- The fuel additive nozzle is removed or replaced.
- The catalytic oxidizer is removed or replaced.
- The DPF regeneration MIL is on and maintenance is performed.
- The DPF regeneration control module is replaced.

BMS RESET

The Battery Management System (BMS) allows the scan tool to evaluate the battery charge state, monitor the close-circuit current, register the battery replacement, and activate the rest state of the vehicle.

This function enables you to perform a resetting operation on the monitoring unit of vehicle battery, in which the original low battery fault information will be cleared and battery matching will be done.

Battery matching must be performed in the following cases:

- Main battery is replaced. Battery matching must be performed to clear original low battery information and prevent the related control module from detecting false information. If the related

control module detects false information, it will invalidate some electric auxiliary functions, such as automatic start & stop function, sunroof without one-key trigger function, power window without automatic function.

- Battery monitoring sensor. Battery matching is performed to re-match the control module and motoring sensor to detect battery power usage more accurately, which can avoid an error message displaying on the instrument panel.

THROTTLE

Throttle Position Sensor (TPS) Match, this function enables you to make initial settings to throttle actuators and returns the “learned” values stored on ECU to the default state. Doing so can accurately control the actions of regulating throttle (or idle engine) to adjust the amount of air intake.

TPMS RESET

Tire Pressure Monitor System (TPMS) Reset allows you to quickly look up the tire sensor IDs from the vehicle ECU, as well as to perform TPMS replacement and reset procedures after tire sensors are replaced.

This function allows you to quickly look up the tire sensor IDs from the vehicle’s ECU, as well as to perform TPMS replacement and sensor test.

- After the tire pressure MIL turns on and maintenance is performed, the tire pressure resetting function must be performed to reset tire pressure and turn off the tire pressure MIL.
- Tire pressure resetting must be performed after maintenance is performed in the following cases: tire pressure is too low, tire leaks, tire pressure monitoring device is replaced or installed, tire is replaced, tire pressure sensor is damaged, and tire is replaced for the car with tire pressure monitoring function.

ABS BLEEDING

Anti-lock Braking System (ABS) Bleeding allows you to perform various bi-directional tests to check the operating conditions of ABS.

1. When the ABS contains air, the ABS bleeding function must be performed to bleed the brake system to restore ABS brake sensitivity.

2. If the ABS tablet, ABS pump, brake master cylinder, brake cylinder, brake line, or brake fluid is replaced, the ABS bleeding function must be performed to bleed the ABS.

3. After the oil in the brake oil tank is seriously insufficient or the brake fluid is replaced, ABS Bleeding is also required

① When performing ABS Bleeding, it is necessary to unscrew the exhaust screw of the ABS pump.

① After completing the tire pressure sensor learning, it takes a while for the fault light to go out.

① Tire pressure imbalance will also cause the tire pressure light to light up.

INJECTOR CODING

This function can write the identification code of the fuel injector into the ECU so that the ECU can recognize and work normally. Write injector actual code or rewrite code in the ECU to the injector code of the corresponding cylinder so as to more accurately control or correct cylinder injection quantity.

After the ECU or injector is replaced, injector code of each cylinder must be confirmed or re-coded so that the cylinder can better identify injectors to accurately control fuel injection.

① After cleaning, generally there is no need to do the coding matching function.

① The identification of the fuel injector includes its working accuracy value and type value. When replacing it, you need to find the corresponding model for replacement.

① At present, mainstream cars support injector coding function

GEARBOX MATCH

After changing the gearbox or changing the gearbox ECU, you need to use the gearbox matching function to re-match the engine and the gearbox.

***Cautions!**

Before resetting the gearbox, please check the gearbox control unit to ensure that there is no fault code. If there is a fault code, the gearbox memory function cannot be reset. Please road test after reset.

SUSPENSION

This function can adjust the height of the vehicle body. When replacing the body height sensor in the air suspension system, or control module or when the vehicle level is incorrect, you need to perform this function to adjust the body height sensor for level calibration.

The air suspension system reset function enables the tablet ECU to match the current air suspension system information, thereby ensuring the normal damping effect of the vehicle when driving.

Application scenarios:

- The shock absorber is not the same height due to air leakage, maintenance, replacement, etc.;
- After replacing the air pump assembly;
- After replacing the electronic control module.

WINDOWS INITIALIZATION

This function is to match the windows to restore the initial memory of the ECU and restore the automatic raising and lowering functions of the power window. Usually when the vehicle window fails or after replacing the window glass, we need to use this function to initialize the car window.

SEAT CALIBRATION

This function is suitable for the matching of replacement and maintenance seats with memory function. After the seat fails or is replaced or repaired, it is generally necessary to use this function to match the seat.

① Needed for cars with seats with memory function, general gasoline cars don't need.

HEADLIGHT

This function is used to initialize the adaptive headlight system. It refers to the adaptive front lighting system (when using bi-xenon headlights at night), it can be rotated to the sides, pressing the button means that they remain direct, and do not turn when you turn. After replacing the headlights, the adaptive headlight system needs to be matched.

ECU CONFIGURATION

When a car with a high-level configuration and a car with a low-level configuration share the same ECU, or you need to change or add some features unique to the high-end vehicles, you can use this function to support the activation of the hidden functions of the car (except those that are not supported by the hardware). Different hidden functions may require different operation steps, please be sure to operate under the guidance.

Cautions!

- The functions that the original ECU must support can be flashed out.
- Brushing to hide will not destroy the ECU system layer, but only open and close some functions.
- Most of them can be re-flashed multiple times.

Support cars:

Volkswagen, Toyota, BMW, Ford, Mazda

***A/F RESET**

This function is applied to set or learn Air/Fuel ratio parameters.

***STOP/START RESET**

This function is used to open or close the automatic start-stop function via setting the hidden function in ECU (provided that the vehicle has a hidden function and supported by hardware).

AIRBAG RESET

Supplemental Restraint System (SRS) Reset allows you resets the airbag data to clear the airbag collision fault indicator. Generally, SRS reset is required after airbag replacement

INSTRUMENT CLUSTER

This function allows you to copy, write or rewrite the kilometers in the odometer chip by using the car diagnostic tablet and data cable, so that the odometer can display the actual mileage.

7 REPORT

Diagnostic Report is used for viewing and printing the saved files, such as Live Data, Trouble codes or pictures generated in the process of diagnosis, users also can view a record of which cars have been previously tested. It includes 3 parts:

- **Report**
- **Replay**
- **File Management**

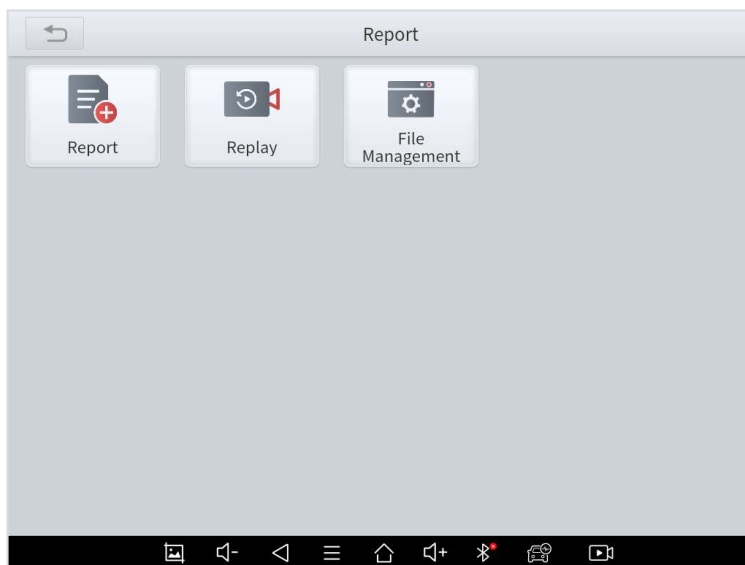

Fig 7-1

REPORT

This feature provides a history of diagnostic reports, where you can view and delete the vehicle's diagnostic reports according to your needs.

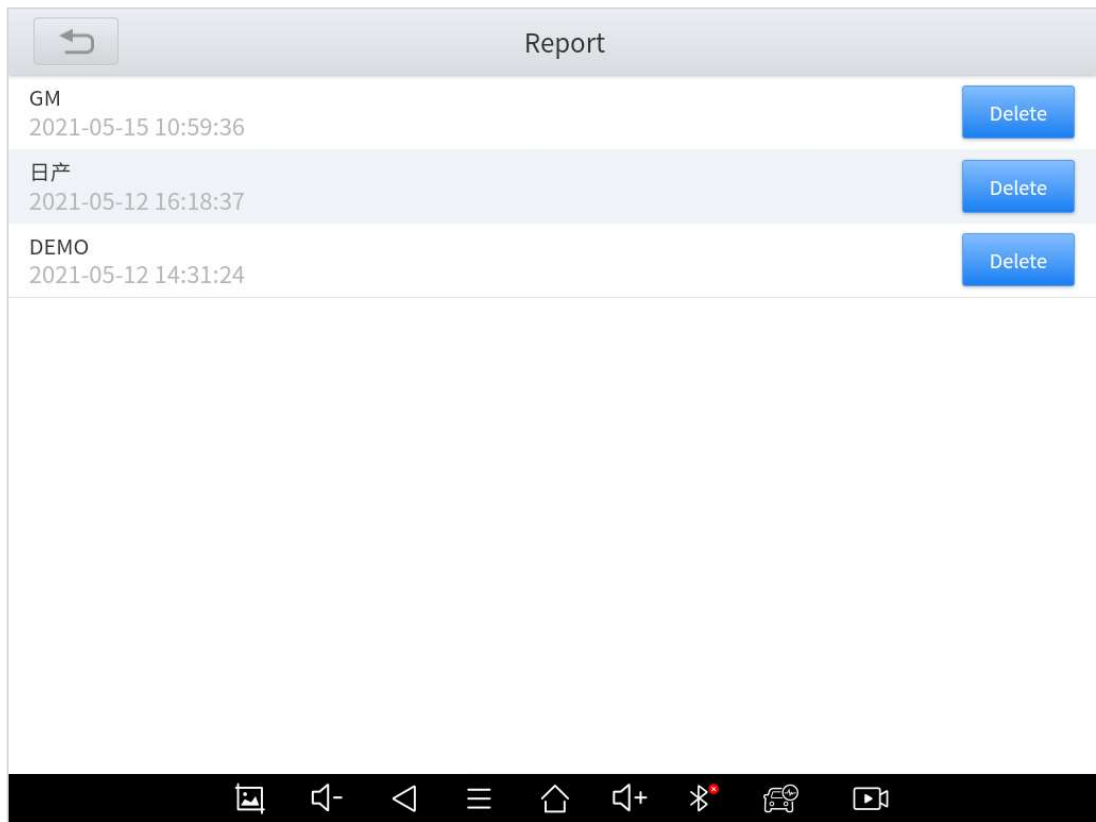

Fig 7-2

When you open the report, located in the header of the table is the studio information you filled in advance in the system setup, then the information of the vehicle, including the diagnosis date and time, VIN number, vehicle brand, diagnosis path, etc., as shown as below:

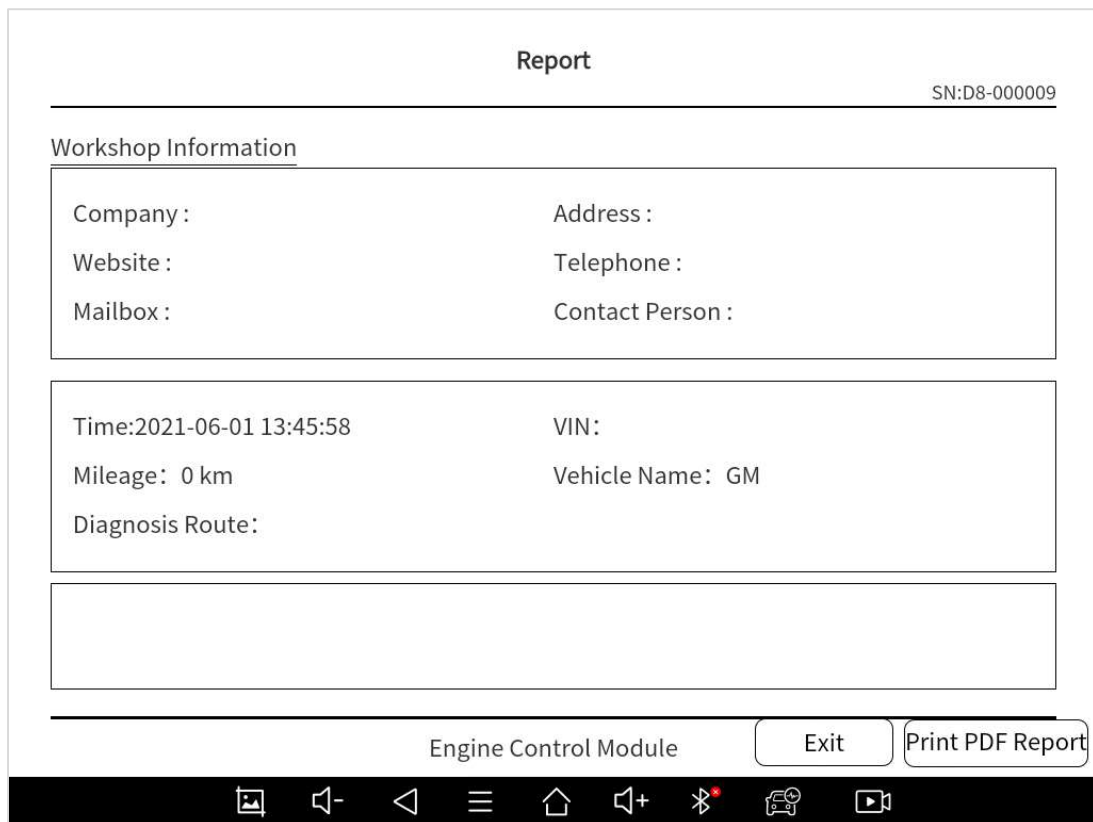

Fig 7-3

■ **Print PDF Report**

As you can see, you also could click " **Print PDF Report** " at the bottom right corner to output the pdf report. If you need to close the report, you could tap on the button "**Exit**".

Please follow below steps to print your report ▼

Step 1: Install an APP that can drive your target printer. Add the printer and input the IP address of the printer in the APP, or you can contact your dealer for help.

Step 2: Back to Android main menu, go to Settings -> Printing-> Turn printer on.

Step 3: Report-> Choose report-> Print PDF Report-> Print

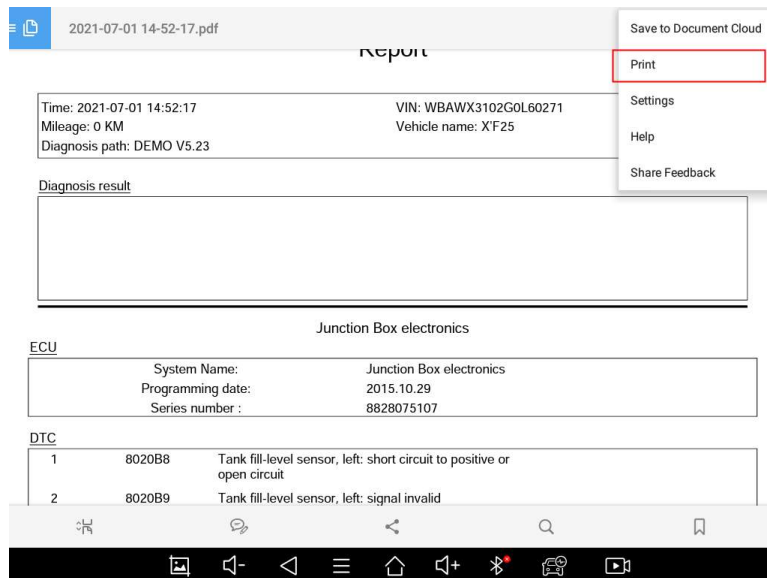

Fig 7-4

Step 4: Click the top-left corner of the screen and choose the printer you added before. Then click the button on the right to print.

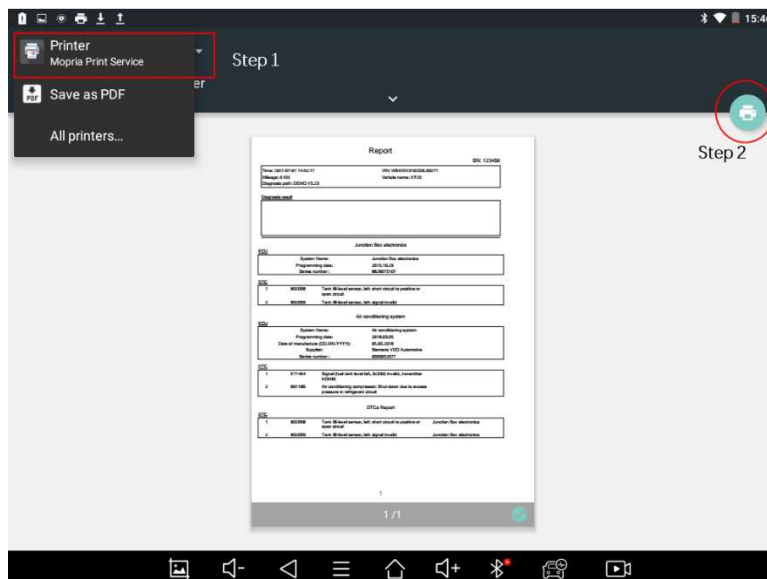

Fig 7-5

REPLAY

This function allows you to replay the living data recorded during the diagnosis process.

Before replaying the living data, please make sure you click on "Save to Reference" button during the diagnosis

FILE MANAGER

This function allows you to check and delete files in the device. Please use this function under the guidance of professionals. Ordinary users are not recommended to use it by themselves, as it may cause software missing or malfunctioning.

8 SETTINGS



Fig 8-1

Click the Settings button to adjust the default settings and view the information of X100MAX Auto Key Programmer. There are several options available in the system settings:

- **Language**
- **Units**
- **Bluetooth**
- **My Workshop Info**
- **VCI Info**
- **About**

LANGUAGE

The languages supported by this device are listed in **Settings**. In areas outside the English area, the default language is English and the local official language. Users can switch between English and local official languages on the device by themselves. If you need to switch other languages, please contact the dealer to unbind the current language configuration and rebind it to the language configuration you need to switch. After the configuration is successfully changed, you can switch the target language.

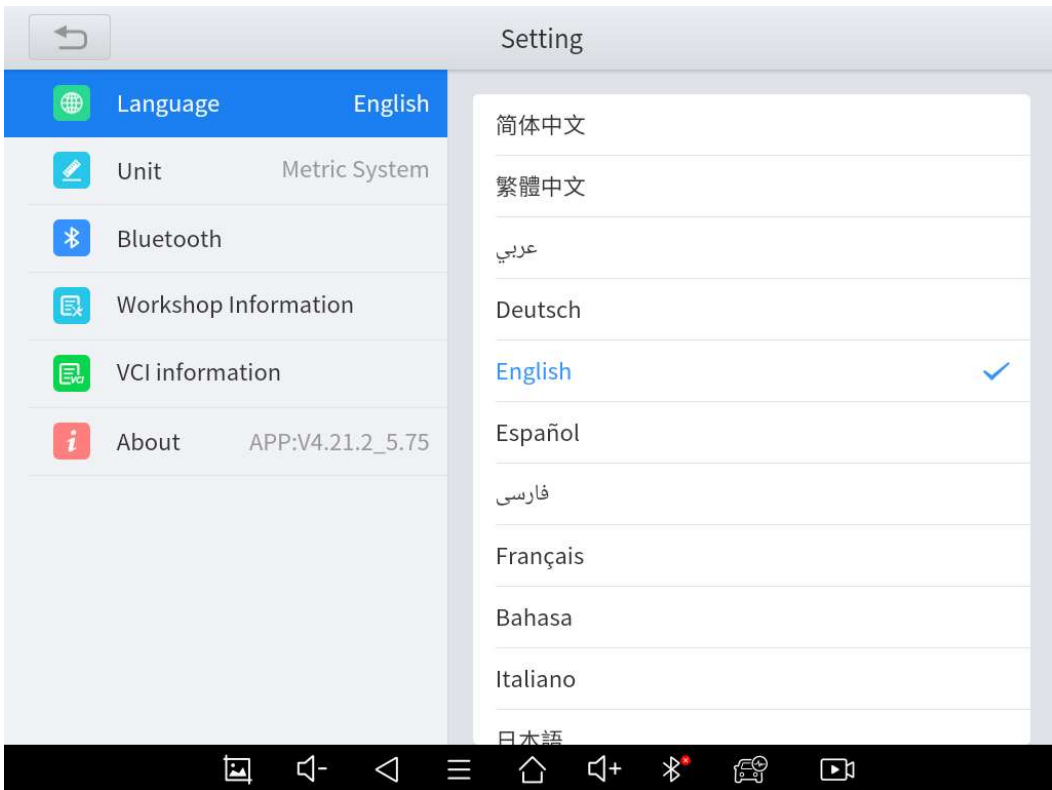

Fig 8-2

① This will only change the language of the APP. If you want to change system language, please go to Android Settings.

■ How to change the language of your software?

Step1: Contact your dealer and leave a message about the language you need and the S/N of your device

Step2: **Settings->Language->Choose language**

Step3: **OS Settings->Language & input->Choose Language**

Step4: Back to **Upgrade**

UNITS

You can switch the unit used by the system. X100MAX provides you with metric and imperial units.

You can directly click on the unit when you need, after the switch is successful, a blue check mark will be shown behind the unit's name.

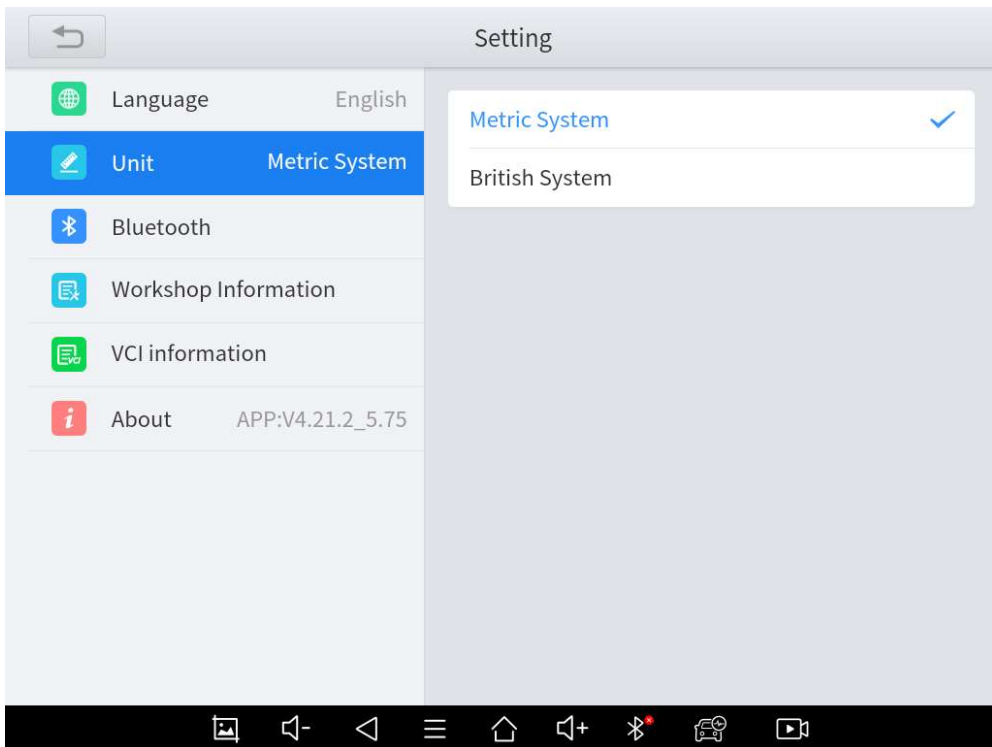

Fig 8-3

BLUETOOTH

You can check the Bluetooth connection status here. If you meet any communication issues, please check the Bluetooth status first.

MY WORKSHOP INFO

Click on **My Workshop Information**, you can input your workshop information here. As shown in the figure below, you just need to fill in the valid information in the corresponding column and click "**SUBMIT**". And then it will show your workshop information in the report when you generate a diagnostic report, including your company name, address, website, telephone, and mailbox.

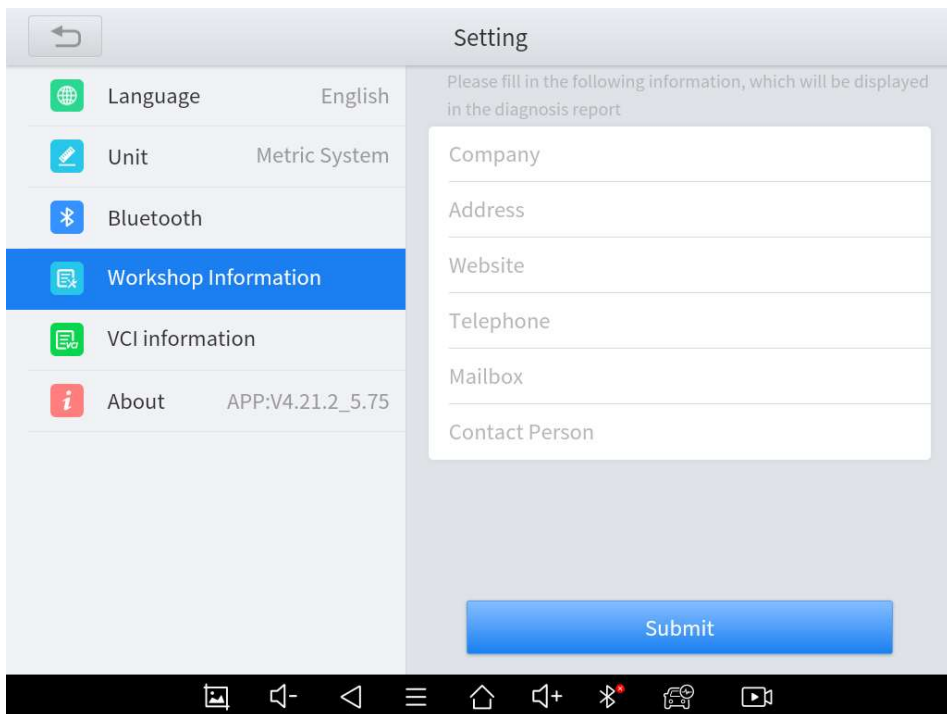

Fig 8-4

VCI INFORMATION

You can view the VCI information here, including the VCI firmware name, the latest firmware version, the currently used firmware version, and the VCI firmware type. If the current firmware version is lower than the latest firmware version, you can choose to update your firmware version and click **"Update VCI Firmware"** to complete the operation.

① Before updating the VCI Firmware, please ensure the tablet's connection to the Internet is stable.

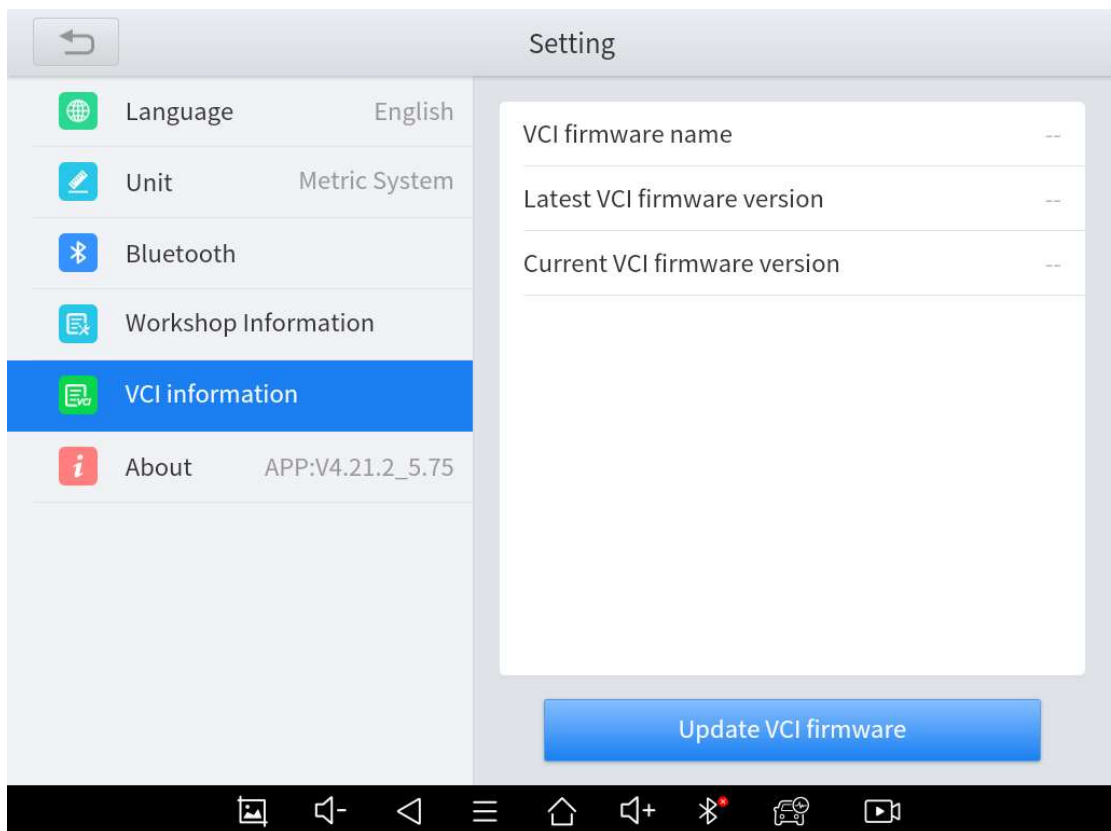

Fig 8-5

ABOUT

Tap on **ABOUT**, you can check the serial number and APP version here.

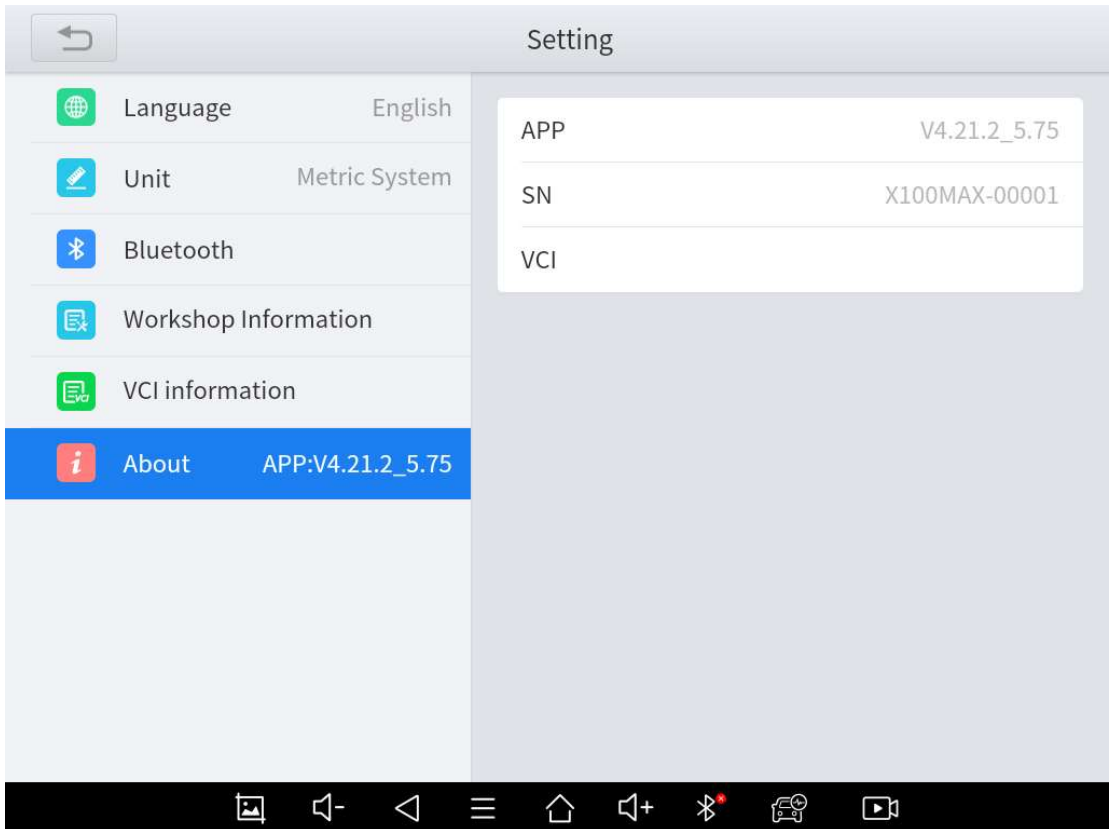

Fig 8-6

9 REMOTE ASSISTANCE

Tap on "**Remote**" to start the TeamViewer quick support program, which is a simple, fast, and secure remote-control screen. You can use this application to enable them to control your tablet on a PC through the TeamViewer software, thereby obtaining temporary remote support from Xtool technical support center.

Tablets and mobile devices running TeamViewer are identified by a globally unique ID. When the remote application is started for the first time, the ID will be automatically generated according to the hardware characteristics and will not be changed in the future. This TeamViewer ID can individually access all TeamViewer clients.

Before launching the remote desktop application, make sure that the tablet is connected to the Internet so that you can access the tablet to receive remote support from a third party. If you encounter problems and are not able to solve them, you could open this application and ask for remote assistance.

To obtain remote support from your partners or Xtool After-service Center:

1. Turn on the power of the tablet.
2. Click **Remote** in the diagnosis application. The TeamViewer screen is displayed, and the device ID will be generated.

3. Your partner must install the remote-control software on his/her tablet by downloading the full version of TeamViewer program (<http://www.teamviewer.com>) online, and then start the software on his/her tablet at the same time, in order to provide support and remote control of the tablet.
4. Provide your ID to the partner or Xtool technician, and then wait for him/her to send you a remote-control request.
5. A pop-up window will be shown for asking you to confirm to allow the remote-control program to control your device.
6. Click **Allow** to accept, or click **Reject** to reject.

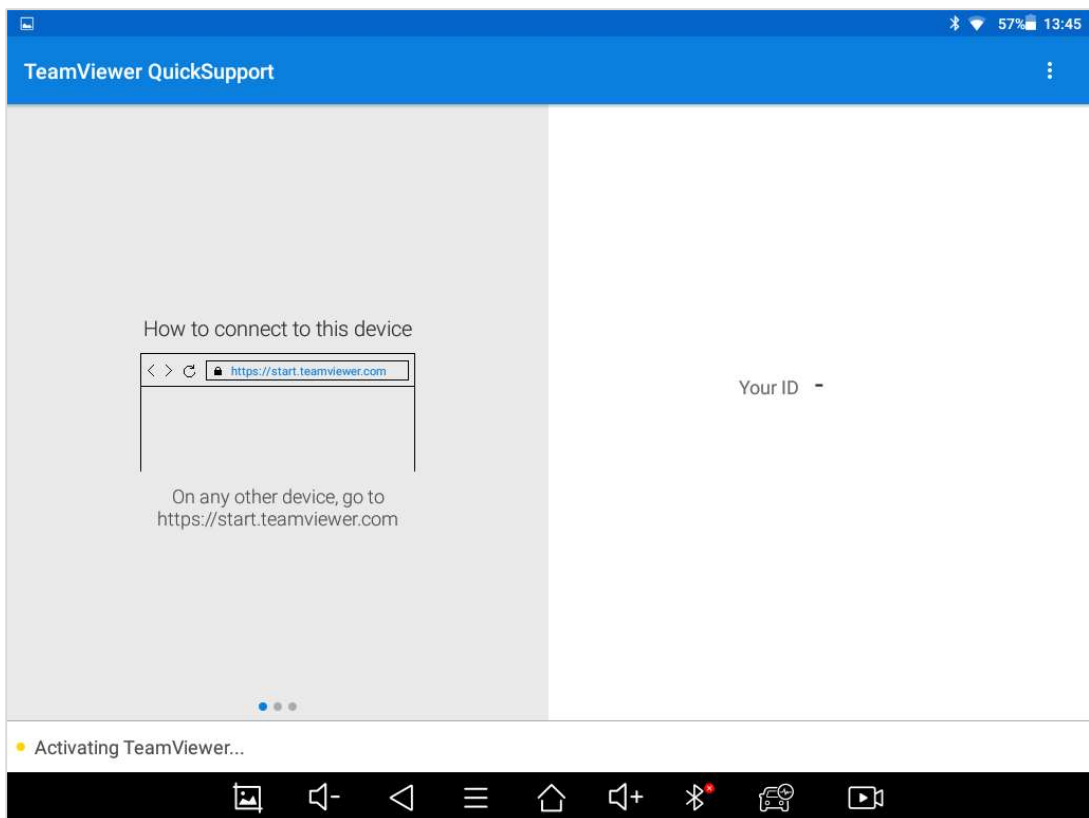

Fig 9-1

SHENZHEN XTOOLTECH INTELLIGENT CO., LTD

Company address: 17&18/F, Building A2, Creativity City, Liuxian Avenue, Nanshan District, Shenzhen, China

Factory address: 2/F, Building 12, Tangtou Third Industrial Zone, Shiyan Street, Baoan District, Shenzhen, China

Service Hotline: 0086-755-21670995/86267858

Email: marketing@Xtooltech.com

Fax: 0755-83461644

Website: www.Xtooltech.com