



# *X100PAD3*

## *Auto Key Programmer*

### User Manual

## Declaration

1. This manual is designed for the usage of X100PAD3, applying to X100PAD3 smart automotive diagnosis platform.

No part of this manual can be reproduced, stored in a retrieval system or transmitted, in any form or by any means (electronic, mechanical, photocopying, recording, or otherwise), without the prior written permission of Xtool.

2. Use the device only as described in this manual. The user will be responsible solely for the after-effects of violating the laws and regulations caused by using the product or its data information; in this case Xtool will not bear any legal responsibility.

3. Xtool shall not be liable for any incidental or consequential damages or for any economic consequential damages arising from the accidents of individual users and the third parties, misuse or abuse of the device, unauthorized change or repair of the device, or the failure made by the user not to use the product according to the manual.

4. All information, specifications and illustrations in this manual are based on the latest configurations and functions available at the time of printing. Xtool reserves the right to make changes at any time without notice.

5. **XTOOL** is the registered trademark of SHENZHEN XTOOLTECH CO.,LTD.

6. In countries that the trademarks, service marks, domain names, logos and the name of the company are not registered, Xtool claims that it still reserves the ownership of the unregistered trademarks, service marks, domain names, logos and the company name. All other marks for the other products and the company's name mentioned in the manual still belong to the original registered company.

You may not use the trademarks, service marks, domain names, logos and company name of Xtool or other companies mentioned without written permission from the trademark holder.

7. Please visit [www.xtooltech.com](http://www.xtooltech.com) for more information on the X100PAD3.

8. Xtool reserves the right for the final interpretation of this manual content.

### **Xtool X100PAD3 User Manual Instructions**

Please read this user manual carefully before using the scanner.

When reading the manual, please pay special attention to the words "Note", "Caution" or "Warning", read them carefully for appropriate operation.

## **Xtool X100PAD3 Diagnosis System Main Unit Maintenance**

Avoid shaking or dismantling the unit as it may damage the internal components.

Do not use hard or sharp objects to touch the LCD screen; do not use excessive force; do not expose the screen to strong sunlight for a long period.

Caution: keep it away from water, moisture, high temperature or very low temperature.

If necessary, calibrate the screen before testing to ensure the accuracy of LCD performance.

Keep the main unit away from strong magnetic fields.

### **Operation Instructions**

For safe operation please follow the instructions below:

Keep the scanner away from heat or fumes when using it.

If the vehicle battery contains acid, please keep your hands and skin or fire sources away from the battery during testing.

Exhaust gas of vehicle contains harmful chemicals, please ensure adequate ventilation.

Do not touch the cooling system components or exhaust manifolds when engine is running due to the high temperatures reached.

Make sure the car is securely parked, Neutral is selected or the selector is at P or N position to prevent the vehicle from moving when engine starts.

Make sure the (DLC) diagnostic link connector is functioning properly before starting the test to avoid damage to the Diagnostic Computer.

Do not switch off the power or unplug the connectors during testing, otherwise you may damage the ECU and/or the Diagnostic Computer.

# Contents

<b>CHAPTER I About X100PAD3</b> .....	1
1. Appearance .....	1
1.1. Front View .....	1
1.2. Back View .....	1
2. Layout of X100PAD3 Tablet .....	2
2.1. Top View of X100PAD3 Tablet .....	2
2.2. Side View of X100PAD3 Tablet .....	2
3. X100PAD3 Technical Parameters .....	2
<b>CHAPTER II How to Use X100PAD3</b> .....	3
1. X100PAD3 Activation .....	3
2. X100PAD3 Main Interface and Functional Buttons Descriptions .....	3
2.1. Main Interface .....	3
2.2. Sub-menu and Functional Buttons .....	5
2.3. Toolbar Functional Buttons .....	5
3. Vehicle Connection Diagnosis .....	6
3.1. Vehicle Connection Test .....	6
3.2. Precautions Before Use .....	6
4. Special function and Diagnosis .....	7
4.1. Menu Options .....	7
4.2. Test Functions .....	9
4.3. Read ECU .....	10
4.4. Read DTCs .....	11
4.5. Clear DTCs .....	11
5. Settings .....	12
6. XCloud .....	13
7. Update .....	13
8. Report .....	13
9. Remote .....	15
<b>CHAPTER III How to Use KC100</b> .....	16
<b>CHAPTER IV Location of Diagnostic Link Connectors on Different Vehicle Models</b> .....	19
1. Diagnostic Link Connectors Locations of Various Vehicle Models .....	19
2. Location Diagram of Vehicle Diagnostic Link Connectors .....	22
3. Diagnostic Link Connectors Terminal Definition and Communication Protocols ....	22

# CHAPTER I About X100PAD3

## 1. Appearance

### 1.1. Front View



### 1.2. Back View



## 2. Layout of X100PAD3 Tablet

### 2.1. Top View of X100PAD3 Tablet



- ①      ②                      ③                      ④      ⑤

- ① USB3.0 interface: Wired data transmission
- ② Mini HDMI interface: Transmission of audio and video
- ③ DB15 interface: Subsequent extended reservation port
- ④ DC charging port: Charge for equipment, use 12V power supply
- ⑤ Power Button: Power on or power off

### 2.2. Side View of X100PAD3 Tablet

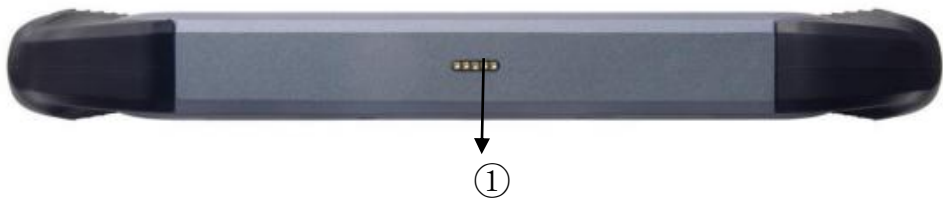

- ① Seat adapter: This is reserved for the socket, and can be charged with charging.

## 3. X100PAD3 Technical Parameters

Operating system: Android

Processor: quad core processor 1.8GHz

Memory: 2G RAM, 64G ROM

Display / touch screen: 1024 • 768 resolution, 8 inch LED Compatible touch screen

Camera: rear camera, 8 million pixels, with flash autofocus.

Sensor: gravity sensor

Audio input / output: microphone, 4 band 3.5 millimeter stereo.

Interface: USB3.0, DC charging port, MINI HDMI, DB15 interface.

Battery: 10000mAh 3.7V lithium polymer battery

Input voltage: +9~+36VDC, compatible with 12V and 24V voltage system.

Working temperature: -20 to 50 C (-4 to 126 C)

Relative humidity: <90%

Appearance size: 275 • 183 • 33.9 (mm)

# CHAPTER II How to Use the X100PAD3

## 1. X100PAD3 Activation

1.1. Please activate X100PAD3 before you use it to test vehicles. And please connect WiFi first.

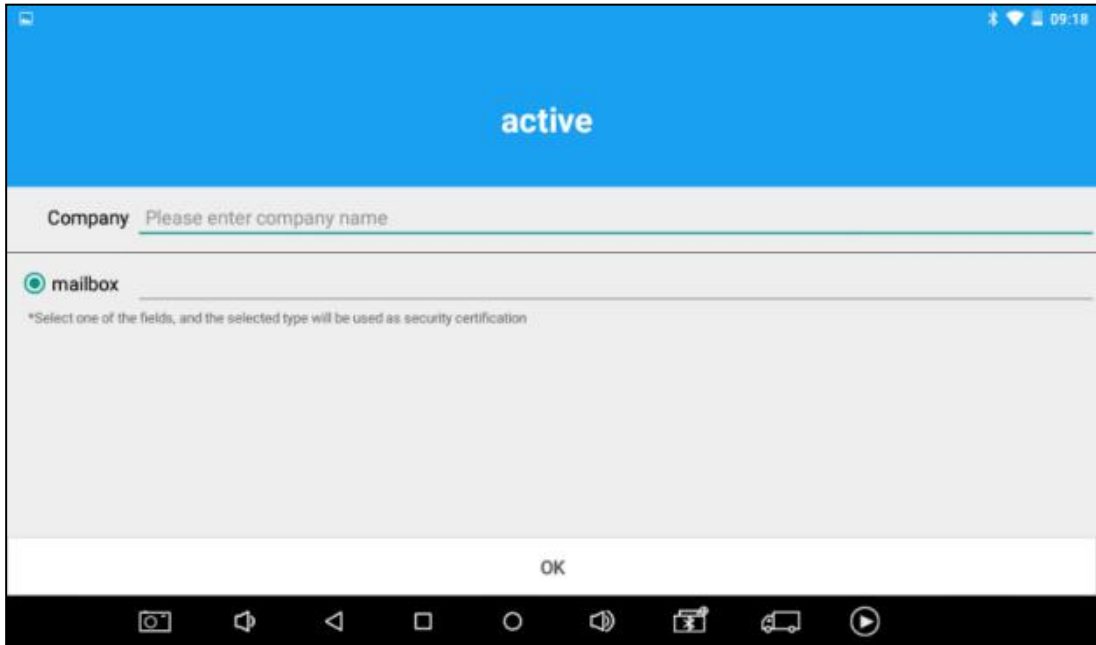

1.2. Input Company name and mailbox, the diagnostic application will start after activation.

## 2. X100PAD3 Main Interface and Functional Buttons Descriptions



### 2.1. Main Interface

Tap on X100PAD3 application icon, the main interface and sub-menus will be shown as below.

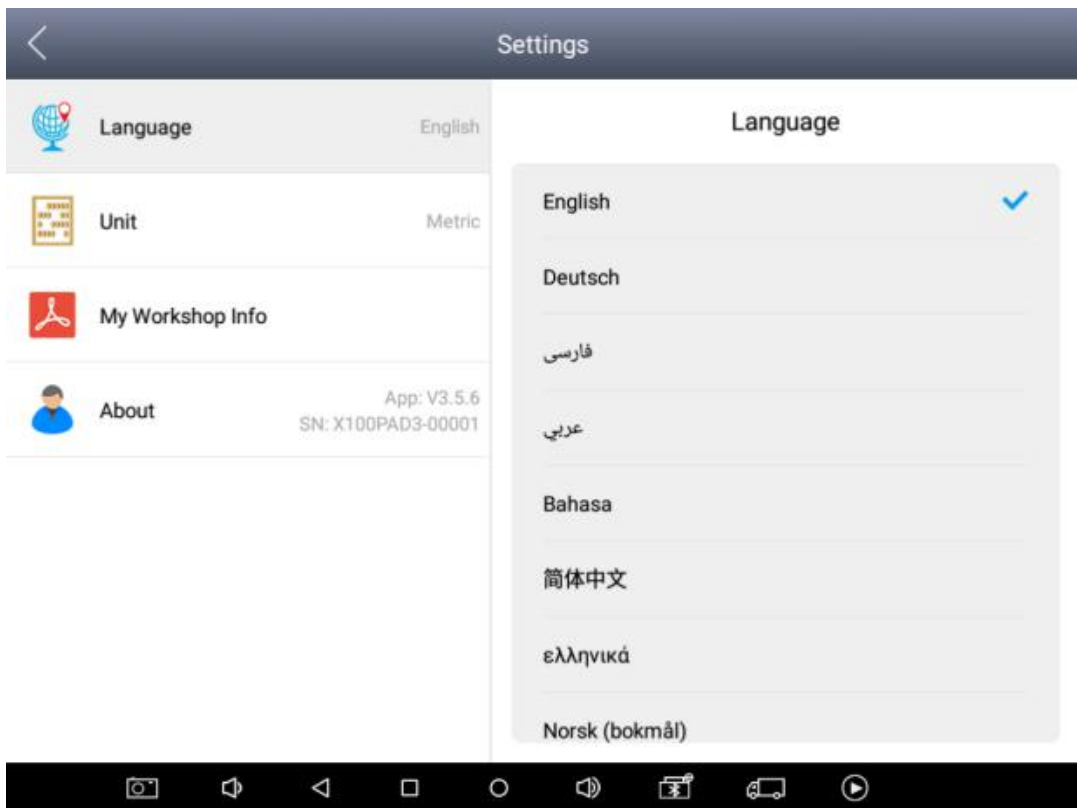











## 2.2. Sub-menus and Function Buttons

Functional Buttons	Functional Descriptions
	<p><b>【Diagnosis】</b> Read vehicle diagnosis information</p>
	<p><b>【Diagnose report】</b> Read vehicle report</p>
	<p><b>【Setting】</b> Language, unit, Bluetooth</p>
	<p><b>【Xtool cloud】</b> Online chatting</p>
	<p><b>【One-click upgrade】</b> Upgrade software</p>
	<p><b>【Remote control】</b> Xtooltech support center and function keys</p>

## Interface Taskbar

Functional Buttons	Descriptions
	【Return to the previous interface】
	【Decrease the volume】
	【Increase the volume】
	【Return to the main interface of Android】
	【Show recently used programs】
	【Screenshot】
	【Back to the diagnosis model interface】
	【Click to record the data, click again to send your feedback to XTOOL service center.】

### 3. Vehicle Connection Diagnosis

#### 3.1. Vehicle Connection Test

a. Turn on X100PAD3 tablet

b. Connect cables and X100PAD3 in following order: ①→②→③→④

c. Switch on the ignition and tap on X100PAD3 application to test vehicles. (Shown as follows)

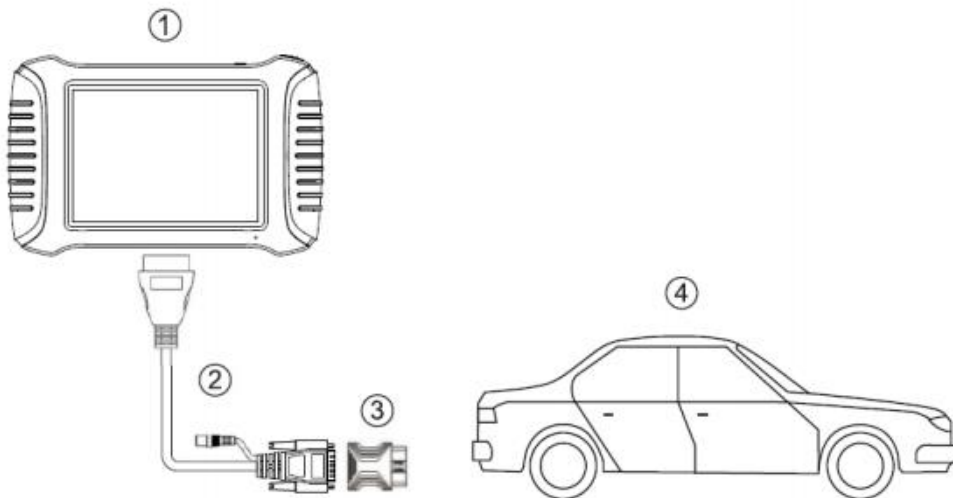

- ① X100PAD3 Tablet
- ② Main cable
- ③ OBDII-16 Adapter (Select other adapters if needed)
- ④ Measured vehicle

### 3.2. Precautions before Use

**3.2.1.** The vehicle power supply has to meet the normal voltage limits DC 9-15V

**3.2.2.** Users should check the position of the DLC port and ensure the OBDII 16pin connector and the DLC port are correctly aligned before attempting to connect.

**3.2.3.** When taking some special functions tests, users are required to operate the device according to operating instructions. For vehicle, it has to strictly meet the requirements, for example, the conditions that some vehicle models need to be reached are as follows: engine temperature 80°C/105°C, turn off the loads (such as headlights, air-conditioner, etc.), put accelerator pedal in released position, etc.

**3.2.4.** If users can not find the tested vehicle model or electronic control system in the X100PAD3 test menu, they may need to update the software or consult Xtool technical service department.

**3.2.5.** Please ensure that only official XTOOL cables and connectors are used to prevent damage to the unit.

**3.2.6.** Before powering off the unit, please ensure that you cancel or complete the current task or function and return to the main interface, then power off.

**3.2.7.** Do not use excessive force to operate the touch screen.

**3.2.8.** During long period of non-use, please disconnect the power and turn off the X100PAD3 unit.

## 4.Special function and Diagnosis

### 4.1. Menu Options

4.1.1. After the X100PAD3 mainframe is connected to the vehicle via main test cable, Immobilization can be performed. The Immobilization interface is shown as below:



4.1.2. X100PAD3 lists mileage adjustment separately. The Dashboard Recovery interface is shown as below:

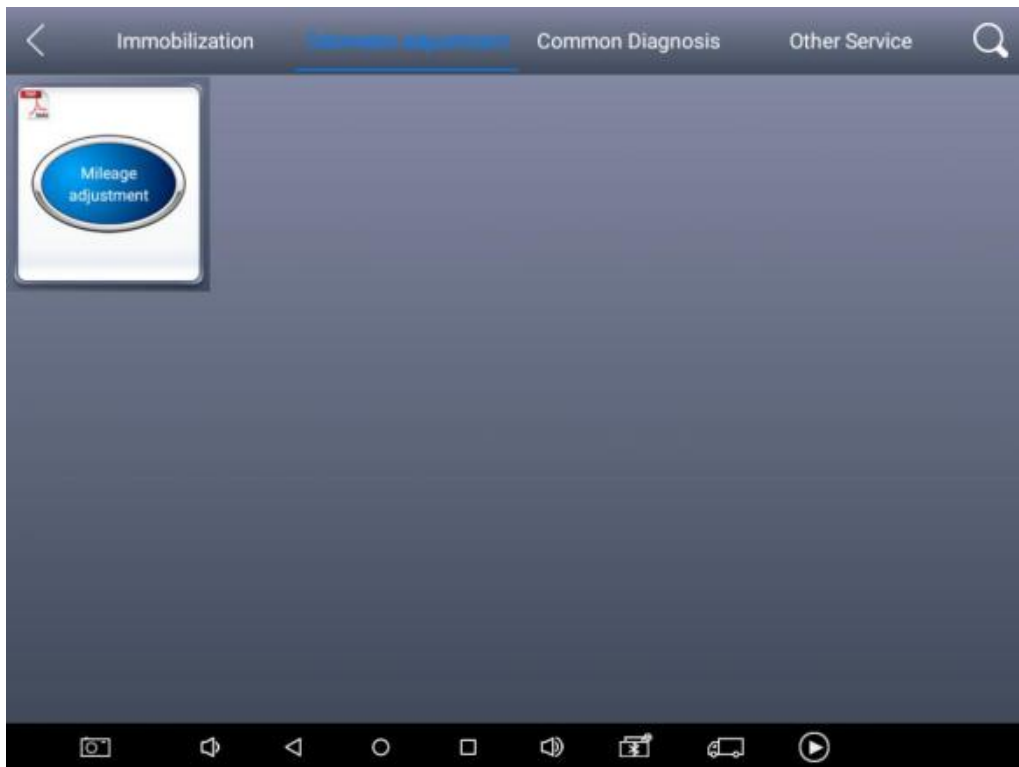

4.1.3. Users can choose the relevant menu for the vehicle being tested: selection for **Europe** will enter the European cars menu, selection for **Asia** will enter the Asian cars menu, selection for **America** will enter the American cars menu.

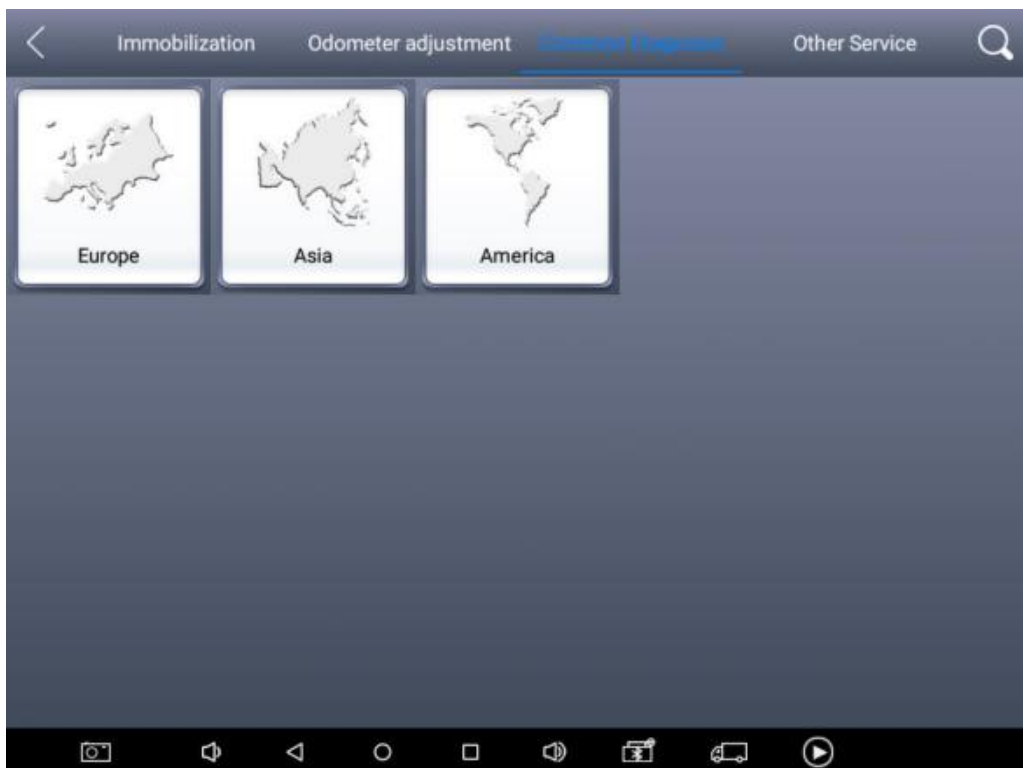

4.1.4. Besides the usual system diagnostic functions, XTOOL also has developed a

series of special diagnostic functions for certain vehicles as follows:

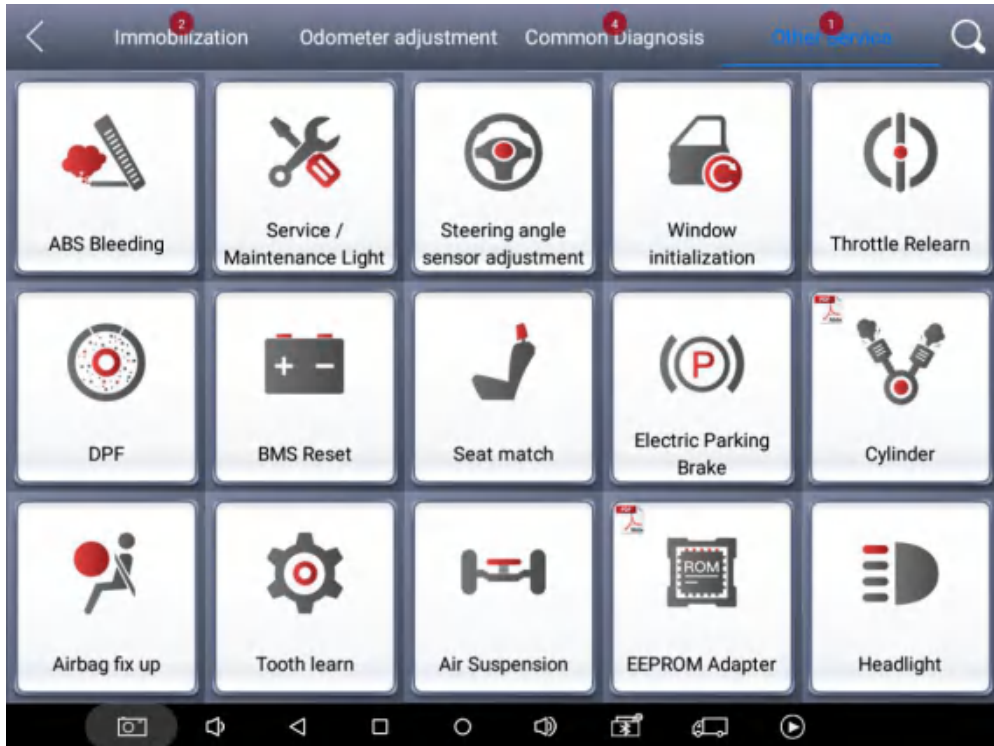

**4.2. Test Functions: it can read and clear faults codes for all systems of vehicles.**

**4.2.1.** Using **BMW** as an example, select **Common Diagnosis**, then select **EUROPE**. Choose the **BMW** word. If the word is not showing on the screen, please swipe up or down to display it.

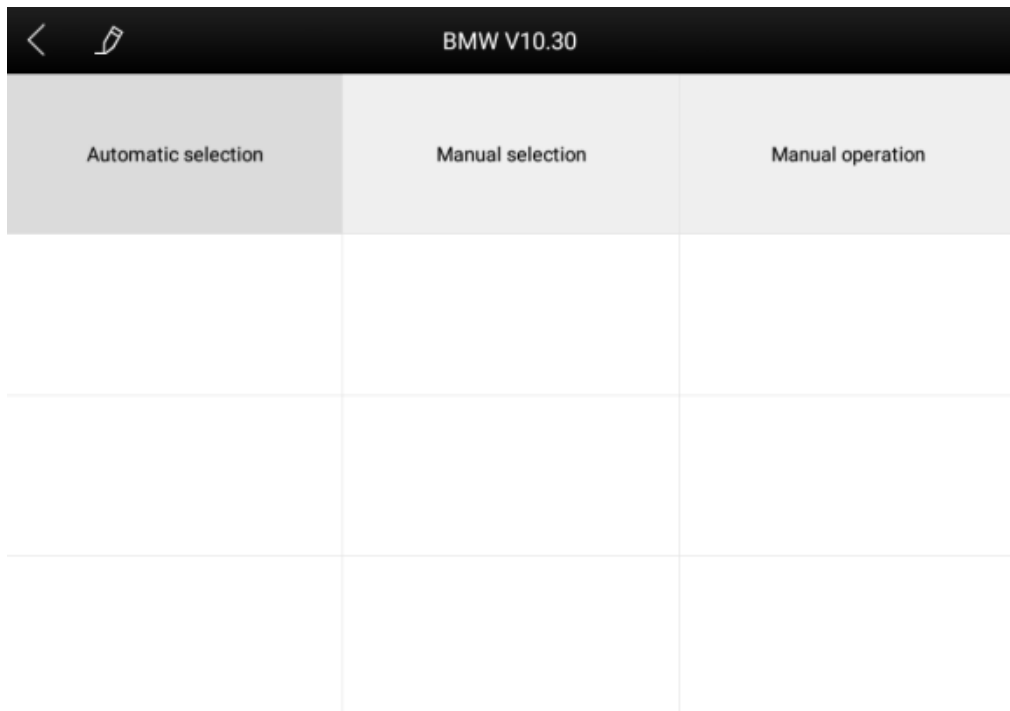

**PLEASE NOTE: Different vehicles have different menus and systems. Common main function menu includes the following options:**



**Read ECU:** This function is to read the ECU version information, which is the equivalent of “System Identification” or “System Information” in some electronic control systems.

This will allow you to read ECU related software and hardware versions, models and production date of diesel engine, part number, etc.

**Read DTCs:** read the trouble codes that are stored in the ECU.

**Clear DTCs:** clear current and historical trouble codes memory in ECU. The trouble codes can not be erased without eliminating the fault that the code relates to. TIP: Save or print the currently stored fault codes before clearing them to provide help in the case of an intermittent fault.

#### 4.2.2. Toolbar function buttons descriptions

Function Buttons	Descriptions
	Return to previous interface
	Print test data
	Click to record the data, click again to send your feedback to XTOOL service center

After clicking the data record button the second time the data feedback page will appear as shown below, showing diagnostic software version, vehicle being tested, and the steps performed in the diagnostic process. Users can then enter the nature of the problem and any other relevant information and send the form to the Xtool engineering department.

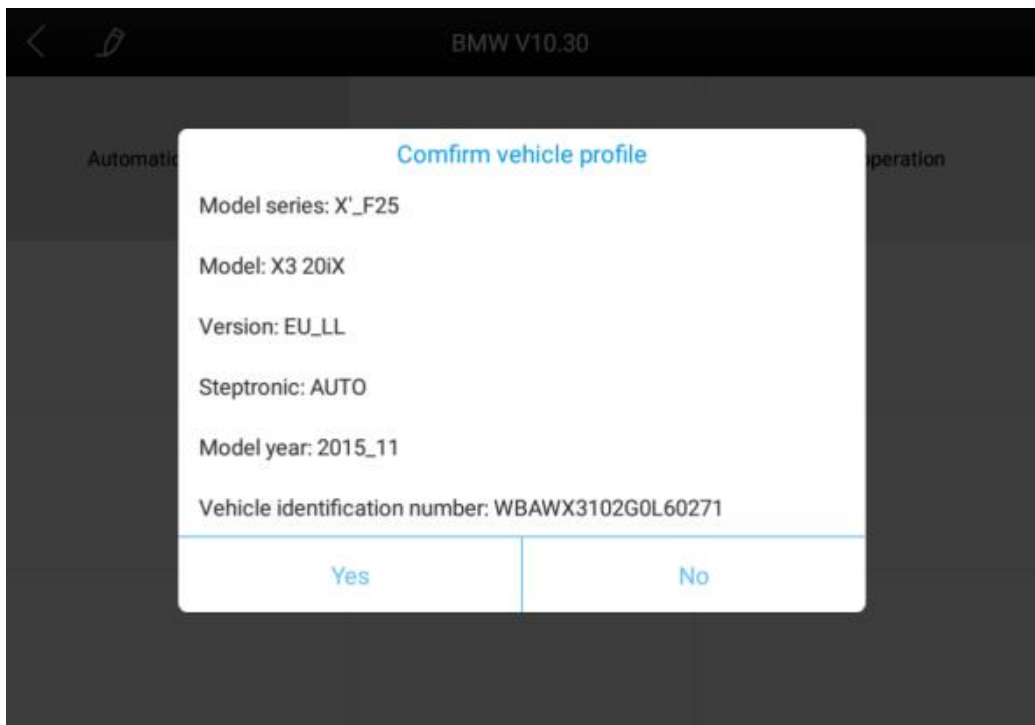

#### 4.3. Read ECU



This function is used to read ECU version information, which is the equivalent of “System Identification” or “System Information” in some electronic control systems. This will allow you to read ECU related software and hardware versions, models and production date of diesel engine, part number, etc. shown below:

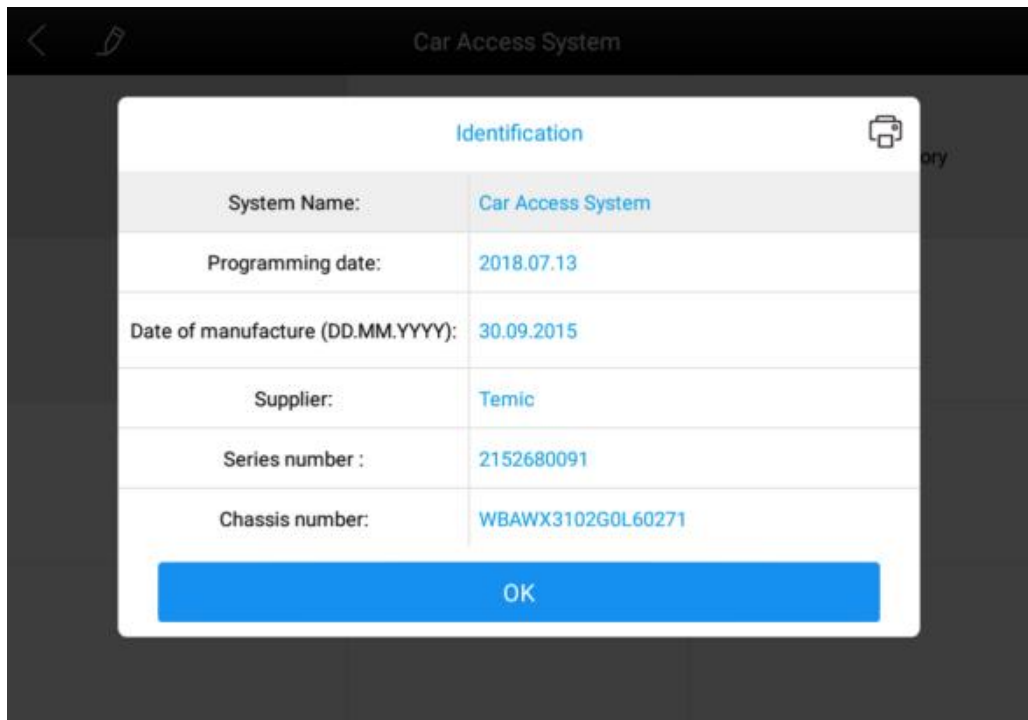

#### 4.4. Read DTCs

Select **Read Fault Codes** to read the trouble codes stored in the ECU. The screen will show the trouble codes and their definition, shown below:

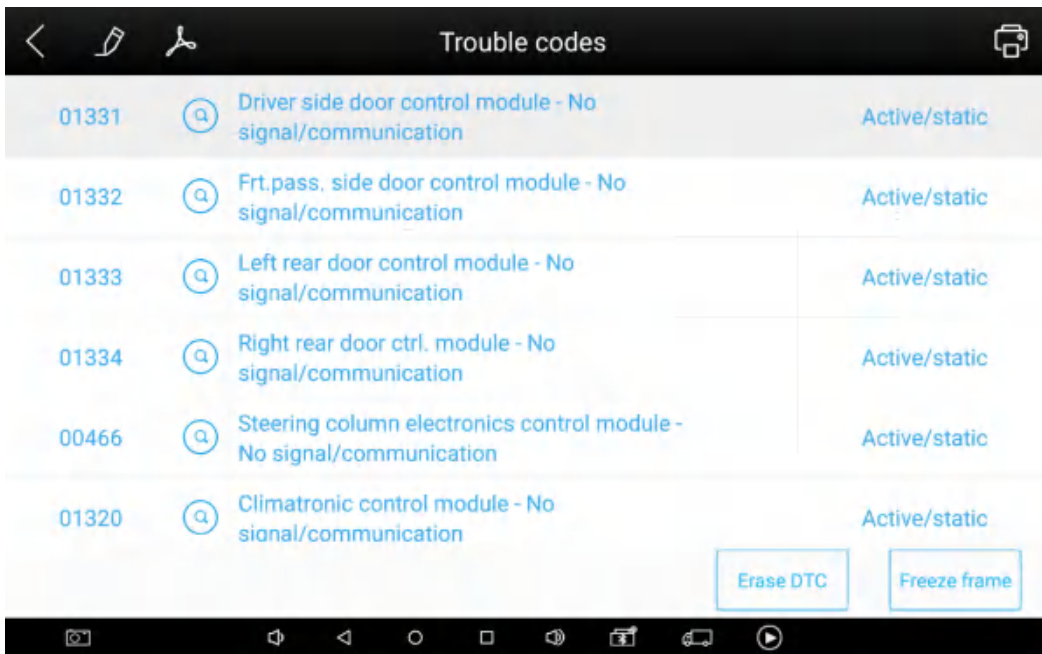

Tip: In the process of diagnosis, if the device shows "System is OK" or "No Trouble Code", it indicates that the ECU has not detected a fault in any of the circuits that it monitors. If there is a fault which is not being recorded it may be that the fault is with a part of the system not under the control of ECU, such as a mechanical system fault. It is also possible that the signal of a system sensor may be incorrect but still within the ECUs stored limits, this can be verified in Live Data.

#### 4.5. Clear DTCs

**4.5.1.** Return to the previous step, select **Clear Fault Codes** to clear the current and historical trouble codes memory in ECU. Performing this function will clear all the current and historical trouble codes. Please ensure that the trouble codes have been recorded before clearing, shown below:

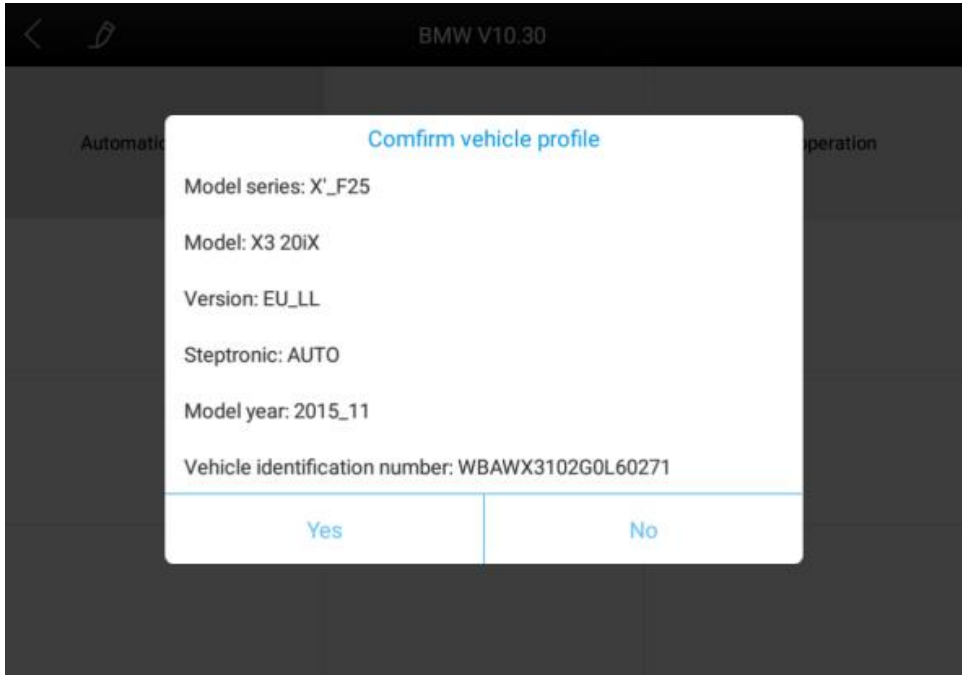

**4.5.2.** Click **YES** to confirm the operation, if the communication is normal, it will show **“Trouble Codes has been Cleared Successfully”** or **“Trouble Codes Cleared”**. Generally, users will need to re-read trouble codes after clearing them to confirm that the trouble codes have been cleared.

## 5. Settings

By selecting **Settings** users can set the language, unit and other system related options.

**Languages:** select the language. Please tick the required option from the multi-language options on the right.

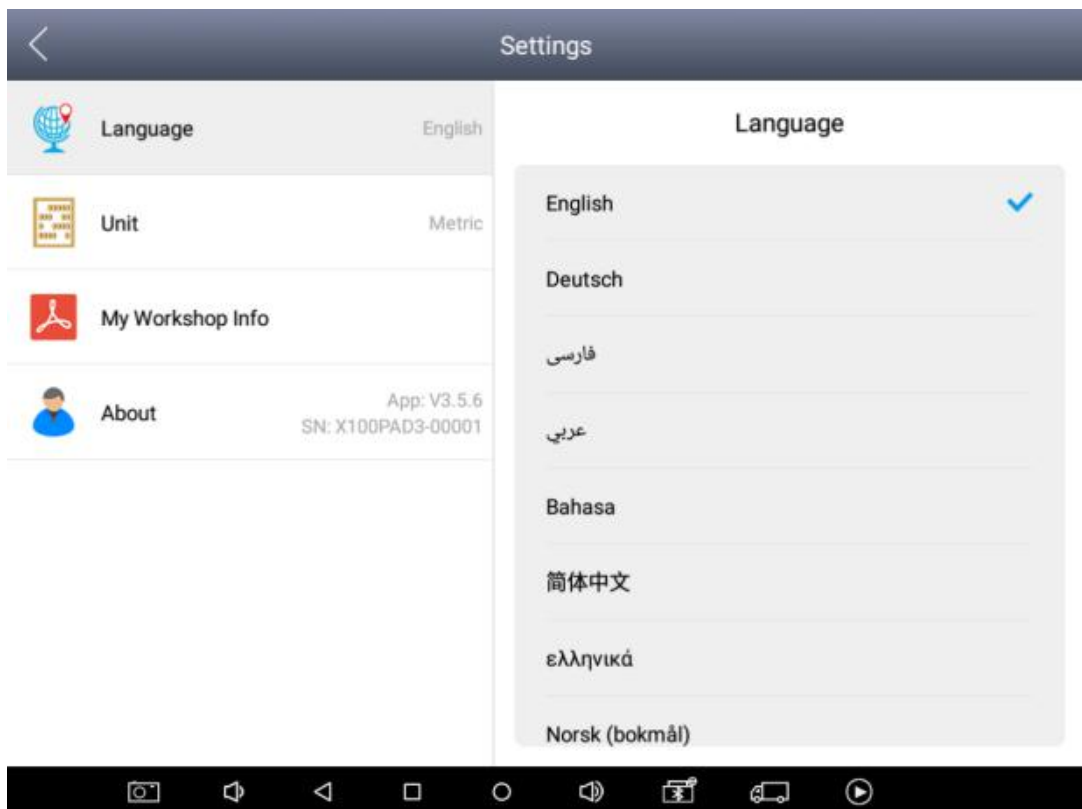

**Units:** Select unit of measurement. Users can select Metric or British Unit.

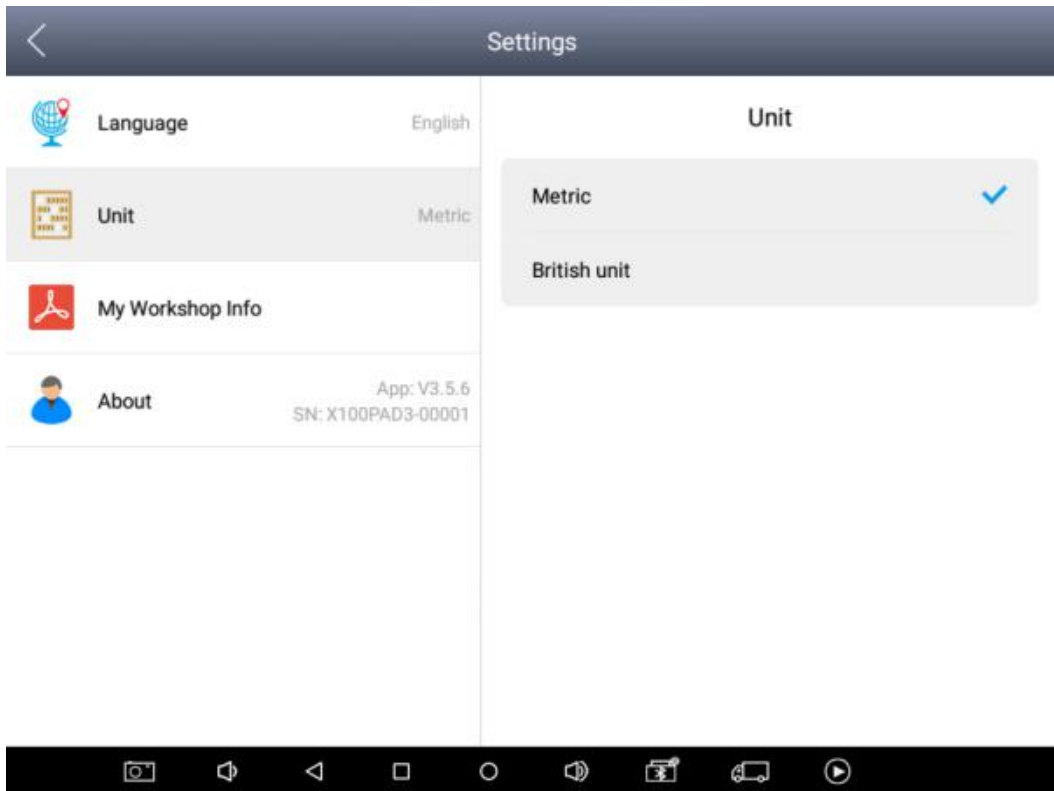

## 6. XCloud (English version is coming soon)

All the auto maintenance technicians who use our products can not only look up the maintenance information that we put on our cloud service platform conveniently, and combine the diagnosis result to query, and communicate with other Xtool users in our forum, but can also access various online databases of maintenance and diagnostic skills and vehicle maintenance plans.

## 7. Update

X100PAD3 updates directly via the Internet using WiFi or wired connection. To access the update application open the X100PAD3 application and click UPDATE , shown below.

		Update			Update all
1	SERVICE LIGHT RESET-ASIA	V16.81	2018-09-26 03:04:57	<div style="width: 0%;"></div> 0%	Update
2	SERVICE LIGHT RESET-CHINA	V18.51	2018-09-26 03:04:59	<div style="width: 0%;"></div> 0%	Update
3	SERVICE LIGHT RESET-EUROPE	V18.21	2018-09-26 03:05:01	<div style="width: 0%;"></div> 0%	Update
4	SERVICE LIGHT RESET-AMERICA	V16.21	2018-09-26 03:05:02	<div style="width: 0%;"></div> 0%	Update
6	DIAGNOSIS-NISSAN PIN DATA	V5.0	2015-04-27 19:55:11	<div style="width: 0%;"></div> 0%	Update
6	DIAGNOSIS-OBDDII	V20.91	2017-07-26 23:07:02	<div style="width: 0%;"></div> 0%	Update
7	DIAGNOSIS-BUICK	V10.51	2018-05-12 08:46:07	<div style="width: 0%;"></div> 0%	Update
8	DIAGNOSIS-CHEVRO LET	V10.51	2018-05-12 08:46:07	<div style="width: 0%;"></div> 0%	Update
9	DIAGNOSIS-CADILLA C	V10.51	2018-05-12 08:46:07	<div style="width: 0%;"></div> 0%	Update

## 8. Report

**Report** is used for viewing and printing the saved files, such as Live Data, Trouble Codes or pictures generated in the process of diagnosis, users also can view a record of which cars have been previously tested. It includes three parts: PDF Files, Pictures and Data Playback.

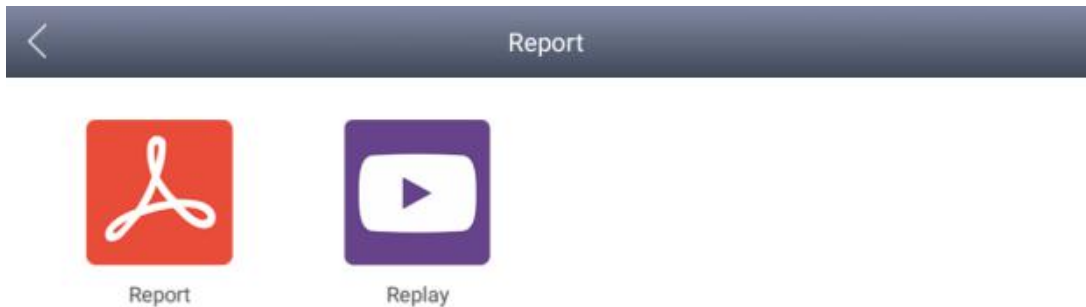

## 8.1. PDF Files:

8.1.1. PDF files are the diagnostic reports of Live Data or Trouble Codes that have been saved during diagnosis. Entering **PDF** will allow you to view and print these reports.

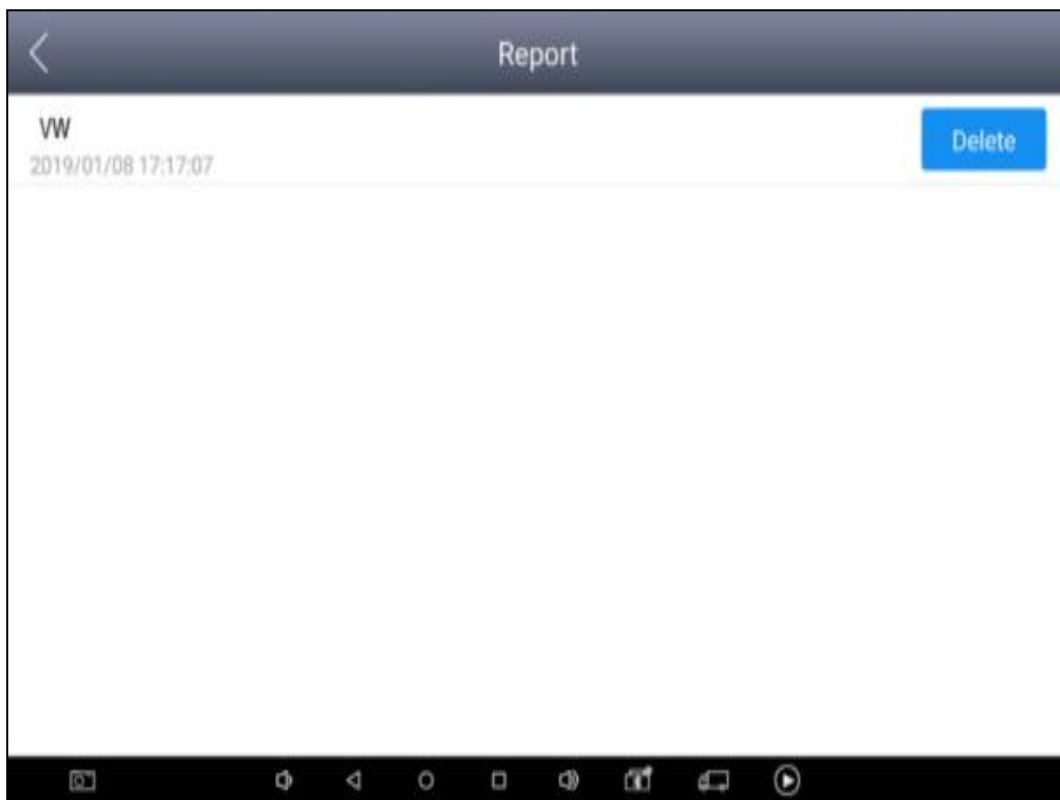

8.1.2 Click PDF icon to generate PDF when you want to save the trouble code report

## 8.2. Data Replay:

With Data Playback you can play back recorded Data.

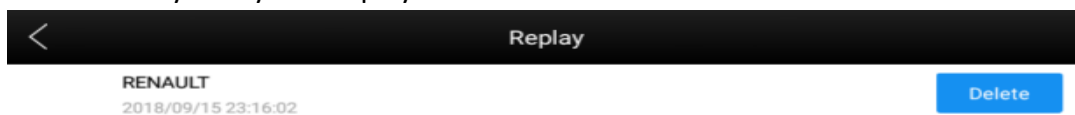

## 8.3. File Management:

Pictures are all the screen capture files saved in the diagnosis process.

## 9. Remote

If users encounter problems and are not able to solve them, they can open this application and ask for remote assistance.

How to get remote assistance from Xtool Technical Assistance Center:

- a. Open X100PAD3
- b. Click **Remote** and open the **Team Viewer** interface. Generate and display device ID.
- c. Your partner will also need to download and install **Team Viewer**.
- d. Inform your partner of your **Team Viewer** ID and password to enable them to begin remote access of the X100PAD3.

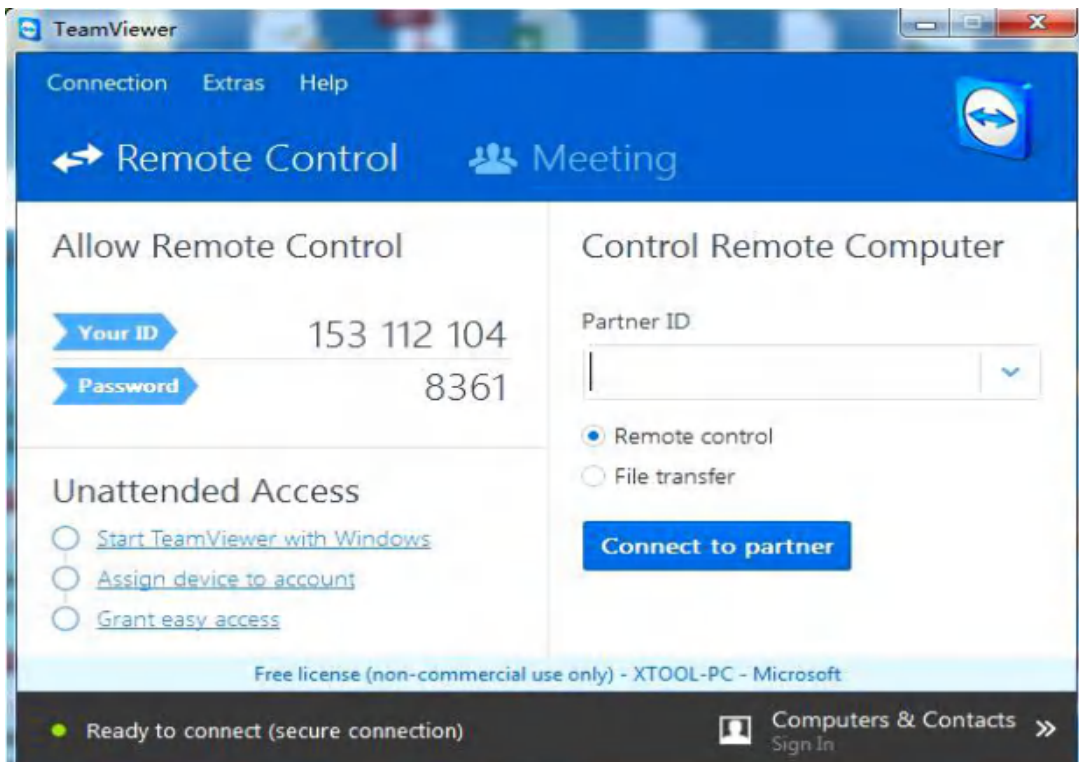



## CHAPTER III How to Use KC100

KC100 works with VW/Audi/Skoda/Seat 4<sup>th</sup> and 5<sup>th</sup> immobilizer software and BMW CAS1-3 and BMW CAS4 immobilizer software. Lets take VW as an example. Since VW 4<sup>th</sup> and 5<sup>th</sup> Immo programming needs online programming, please make sure X100PAD3 connect Internet before doing programming. Please find operation steps as below:

1. Please use main cable and OBDII connector (or other relative connector) to connect between X100PAD3 and your car's OBD port.
2. Please use USB to mini USB cable to connect between X100PAD3 and KC100.



3. Please switch ignition on position, then enter software as following steps:  
Immobilization - VW - 4<sup>th</sup>/5<sup>th</sup> Immobilizer System





4. If your car is 4<sup>th</sup> immobilizer system, please click 4<sup>th</sup> immobilizer system. If your car is 5<sup>th</sup> immobilizer system, please click 5<sup>th</sup> immobilizer system. It will detect your meter type automatically, if it does not detect successfully, you can choose your meter type manually.

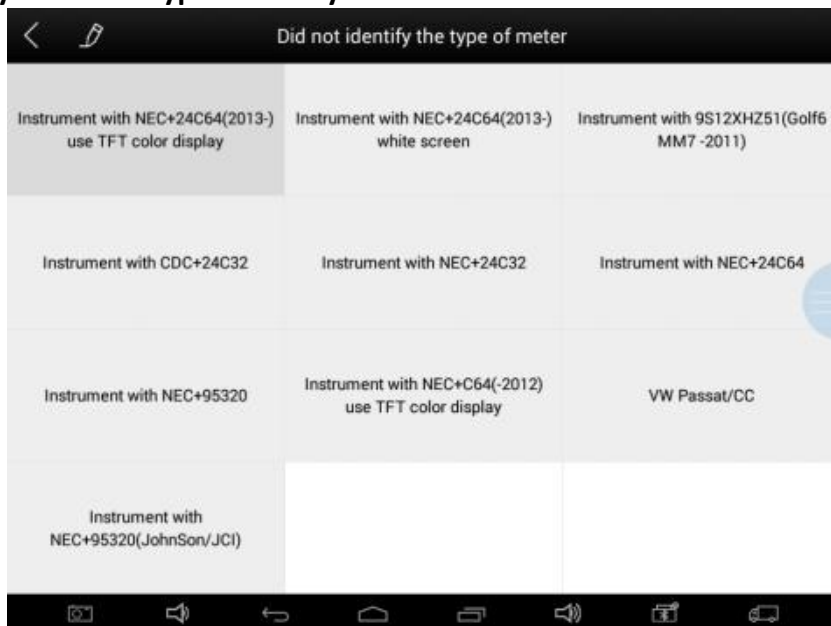

5. Then follow the instructions that software reminds you to copy new keys.

# CHAPTER IV Location of Diagnostic Link Connectors on Different Vehicle Models

## 1. Diagnostic Link Connectors Locations of Various Vehicle Models



\*AUDI A6: the OBD plug is on the lower left side of the dashboard, use SMART OBDII-16 connector.



\*VW Bollywood 1.8: the OBD plug is below the console, use SMART OBDII-16 connector.



\*Benz S320,220 Chassis: the OBD plug is below the dashboard, use SMART OBDII-16 connector.



\*Benz C180: the OBD plug is on the left hand side of the engine bay, use Benz-38 connector.



\*Benz 300SEL 140 chassis: the OBD plug is on the left hand side of the engine bay, use Benz-38 connector.



\*GM Buick: the OBD plug is below the dashboard, use SMART OBDII-16 connector.



\*GM Buick GL8 : the OBD plug is below the dashboard, use SMART OBDII-16 connector.



\*VW POLO: the OBD plug is below the dashboard, use SMART OBDII-16 connector.

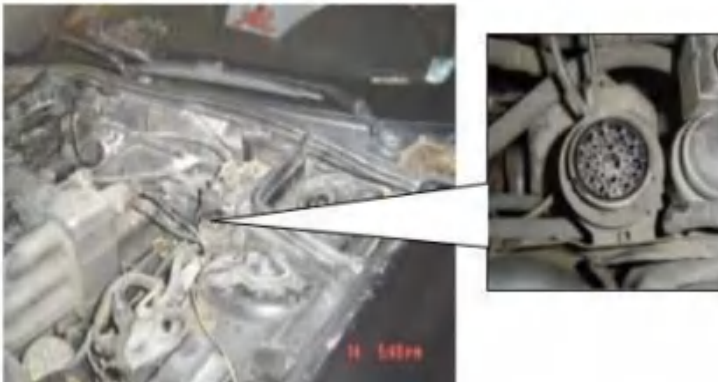

\*BMW 735i: the OBD plug is in the right hands side of the engine bay, use BMW-20 connector.

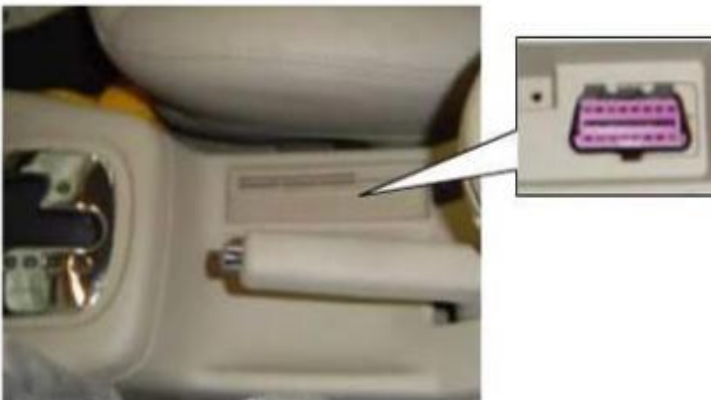

\*VW Passat B5: the OBD plug is behind the gearlever and beside the parking brake lever. Lift the cover to access it. Use SMART OBDII-16 connector.

## 2. Location Diagram of Vehicle Diagnostic Link Connectors

Location diagram of pick-up truck diagnostic link connectors:

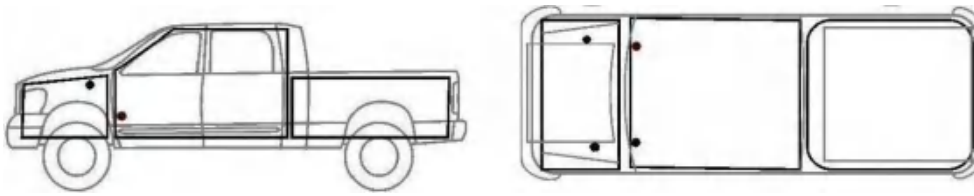

Location diagram of utility vehicles diagnostic link connectors:

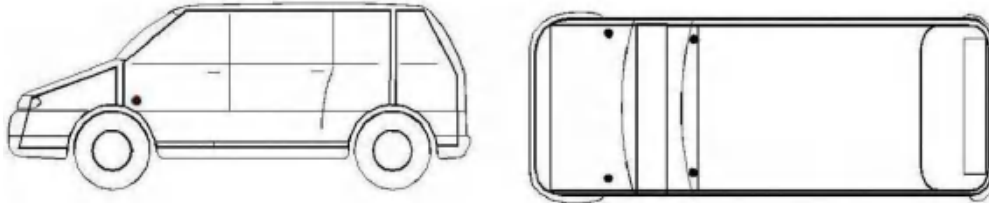

Link diagram of small car diagnostic link connectors:

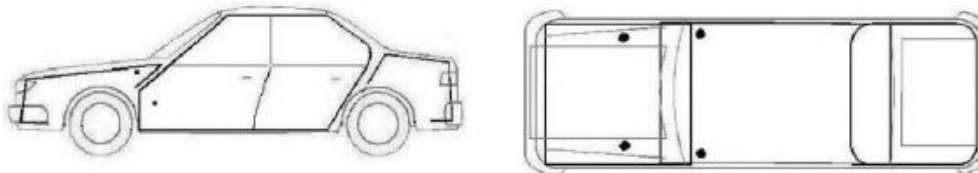

NOTE: Each vehicle manufacturer may use additional pins to diagnose a variety of systems. Not every manufacturer uses the same standard. The function on a certain pin will vary from manufacturer to manufacturer. Verify with the manufacturer.

## 3. Diagnostic Link Connectors Terminal Definition and Communication Protocols

3.1. Standard OBDII Diagnostic Link Connector:

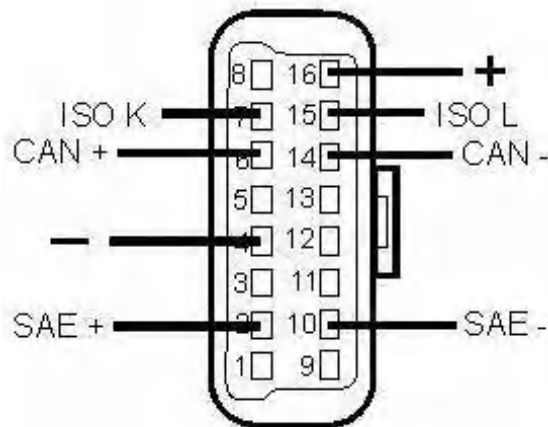

### Pin Definition (Reference material)

Various pin definitions as follows:

1. Manufacturer definition
2. SAE J1850 bus positive
3. Manufacturer definition
4. Bodywork site
5. Signal site

6. ISO 15765-4 defined CAN high
7. ISO9141 and ISO14230 defined K line
8. Manufacturer definition
9. Manufacturer definition
10. SAE J1850 bus negative
11. Manufacturer definition
12. Manufacturer definition
13. ISO 15765-4 defined CAN low
14. ISO9141 and ISO14230 defined L line
15. Permanent positive voltage

[1] 1, 3, 8, 9, 11, 12 and 13 are defined by manufacturer.

[2] 2, 6, 7, 10, 14 and 15 are used for diagnostic communication. Unused definitions can be defined by manufacturers.