

## Chip Identifications

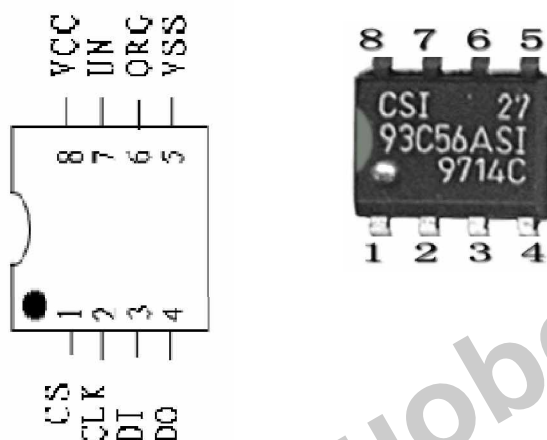

Chips: IC in which stores Mile/Km, audio code and anti-theft code and other data. Most of them have 8 pins; the data stored in can be read/written.

## Adapters

### Remove-free Adapter

- Only available for those we offer wiring diagrams.
- For the odometer with protected lacquer on the circuit board or IC, heat the lacquer and clear it and then to weld.
- Use the 8-colour cables to connect 8-pin (93/25 series) socket from the adapter to the 8 points marked on the wiring diagram, the first cable is for Pin1, and the second for Pin2...the 8th for Pin8.
- Check for correct welding before inserting the adapter into the instrument to adjust!!

Name	Function
93 series	93C14 93C46 93C56 93C86A S130 S220 C46M6 C56M6 C66M6 LC66 59C11 79101 CXK1011 .For cluster with 93 series ICs, such as Honda 2.4.
25 series	25Cxx 68343 For cluster with 25 series ICs, such as Santana 2000.
24 series	24Cxx 85Cxx D6253 D6254 BAW574252
14#93CS56	14#93CS56

## Chips Mounting

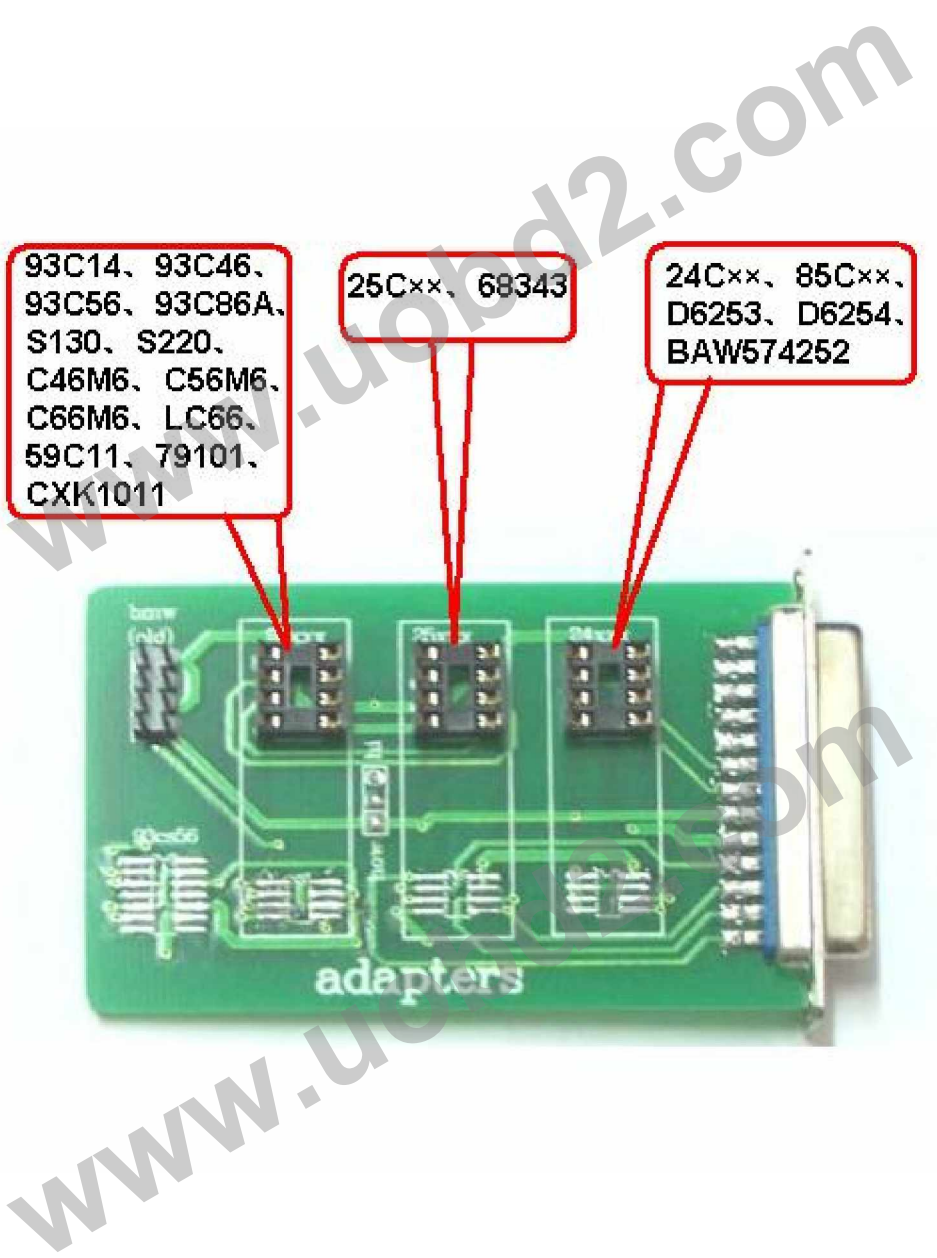
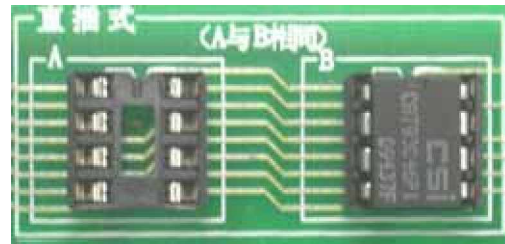
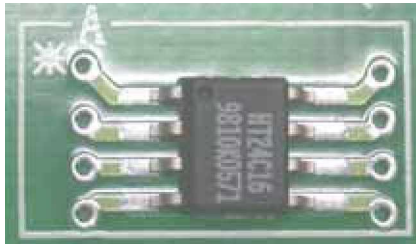

93C14, 93C46,  
93C56, 93C86A,  
S130, S220,  
C46M6, C56M6,  
C66M6, LC66,  
59C11, 79101,  
CXK1011

25Cxx, 68343

24Cxx, 85Cxx,  
D6253, D6254,  
BAW574252

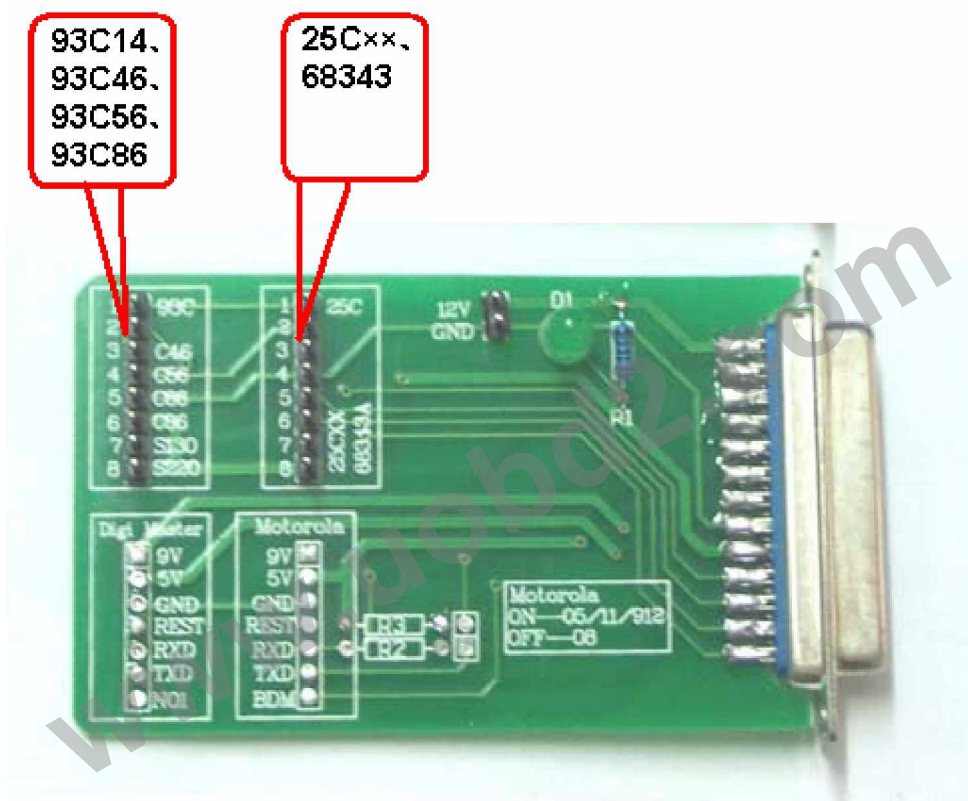

## How to correct the odometer

### Cluster Adjusting

Operation:

1. Types available please refer to Pictures and Charts Collection . If you have a car or cluster not listed to do, please contact the manufacturer. Do not try it yourself or use other type instead to adjust. Or the cluster may be damaged.
2. For some special clusters (say, with 2 chips), please refer to the pictures shown in Pictures and Charts Collection .
3. Some clusters whose hands cannot be pull out. Do read the appendix Attention for Cluster Adjusting first.
4. Save the data before any adjusting to avoid any data lost caused by chip damaged or mis-selecting the type. If data is not correct, it may cause car no start, cluster no displays, and cluster running incorrectly and cluster hand moving in disorder.
5. The instrument will auto-read the original kilometer when adjusting. If similar to the actual Km (difference should less than 100Km), it can be adjusted; otherwise, please contact the manufacturer for solution.
6. It has some original data except that the user saved. When data lost or using a new chip, the original data should be written into before adjusting, or the odometer cannot work properly. You can resume the original data you saved or select "Resume Data" operation to resume the data it has.

7. Should use the original chip to adjust. Use a new one when the original damaged.

8. Odometer adjusting flow:

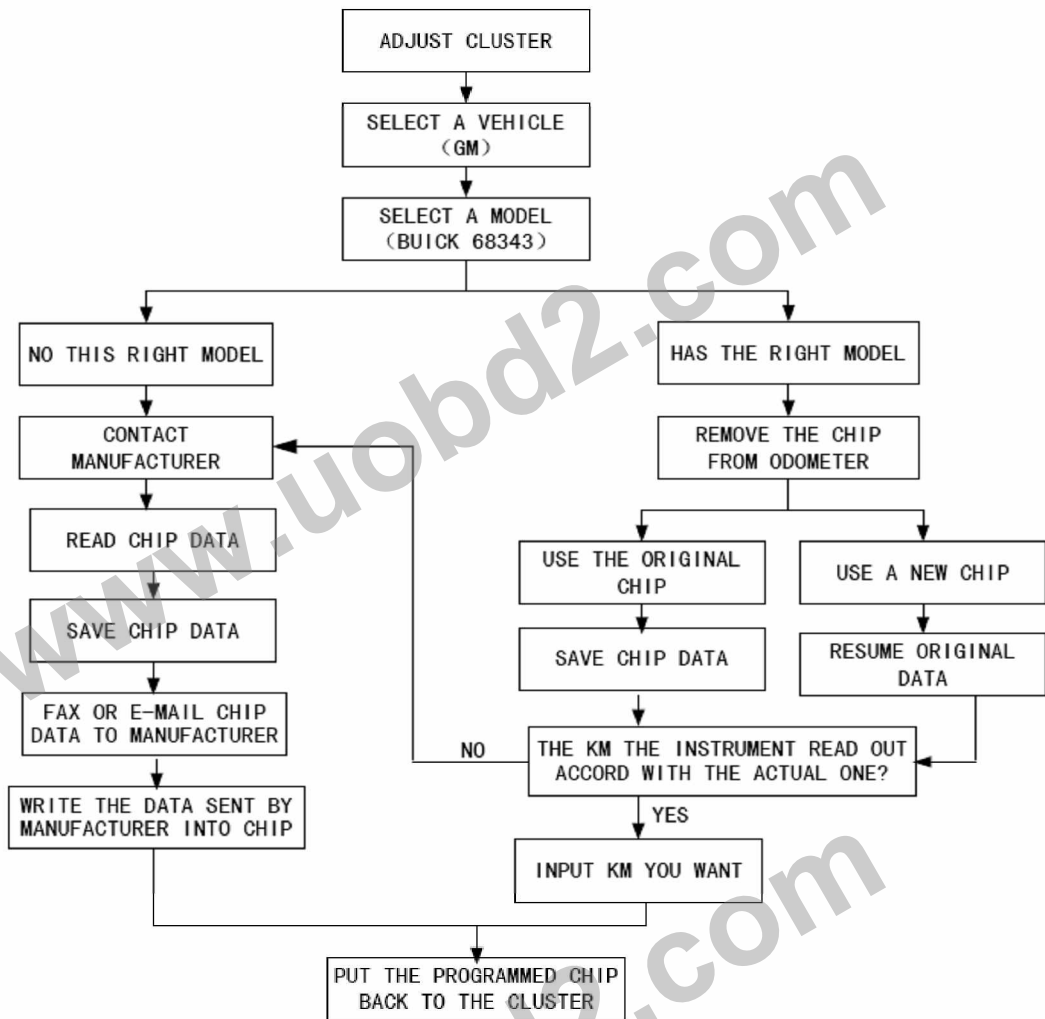

Example: Odometer **BENZ 1998/S320**

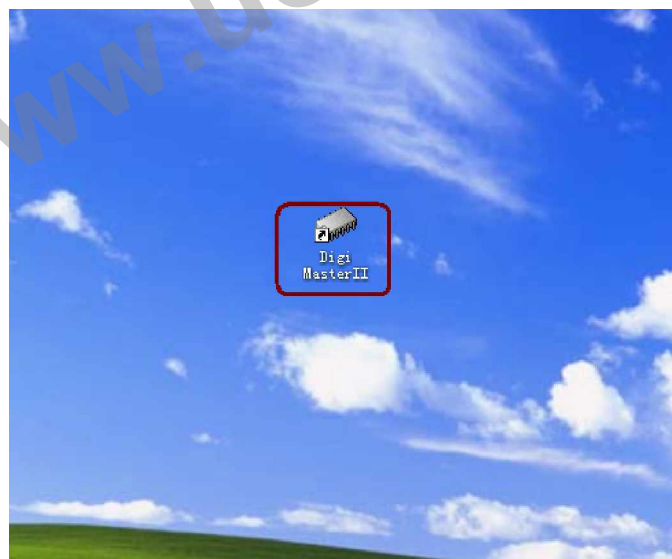

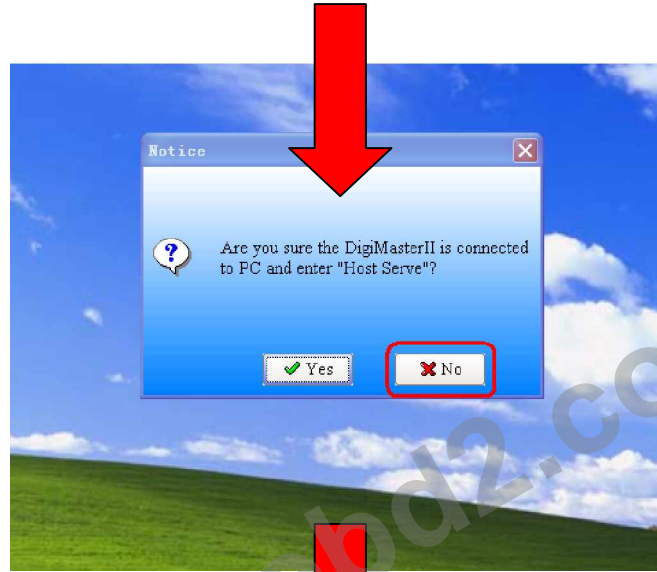



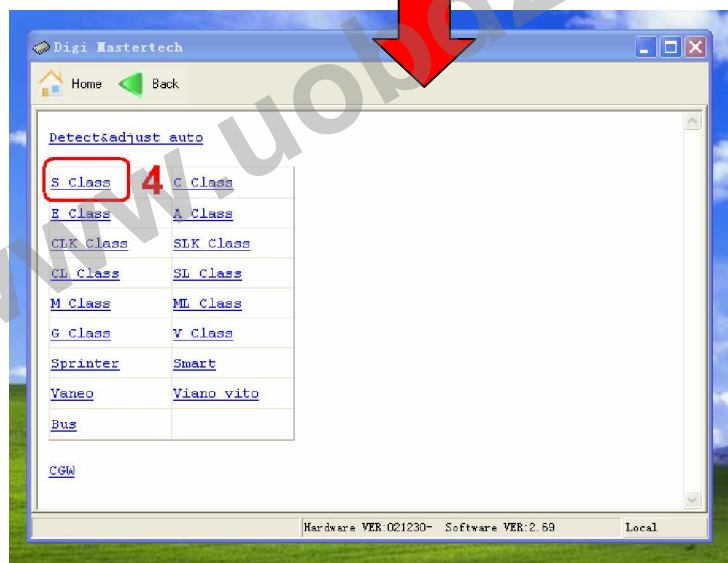
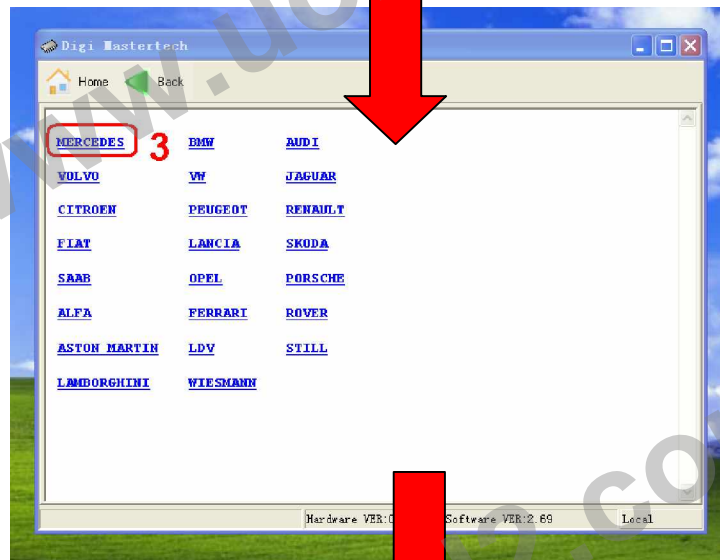
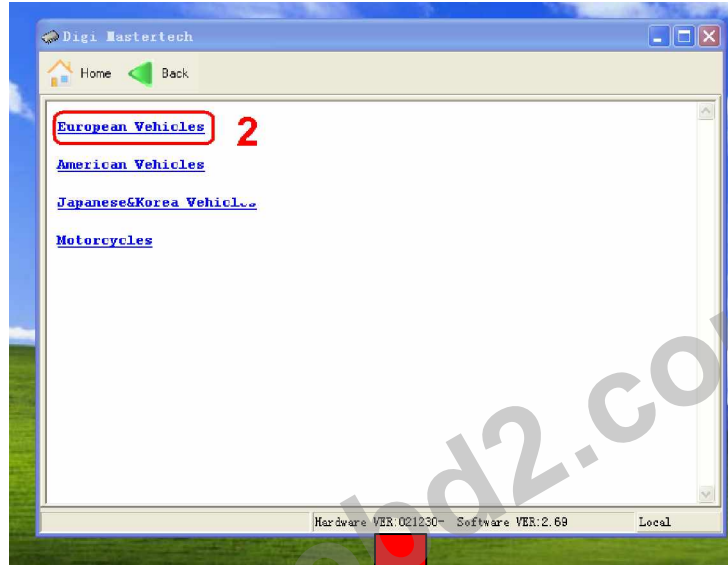

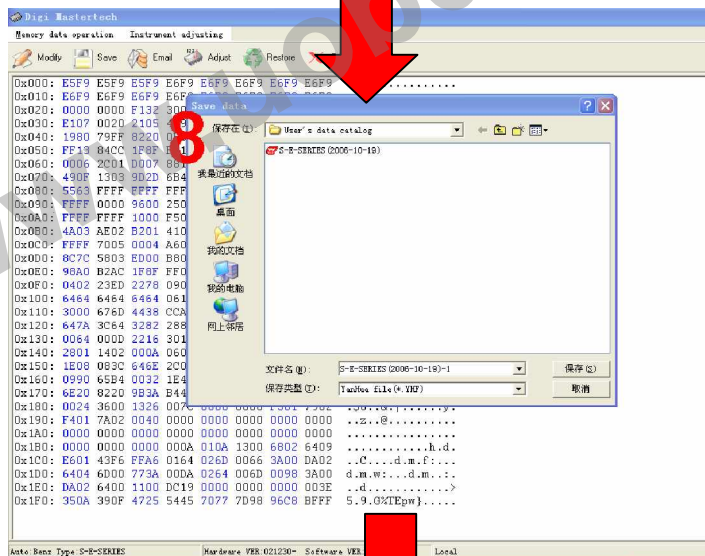
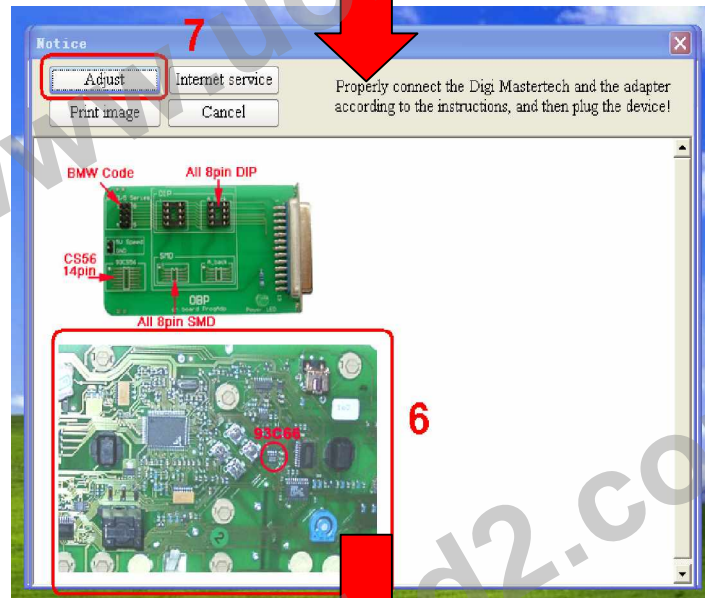
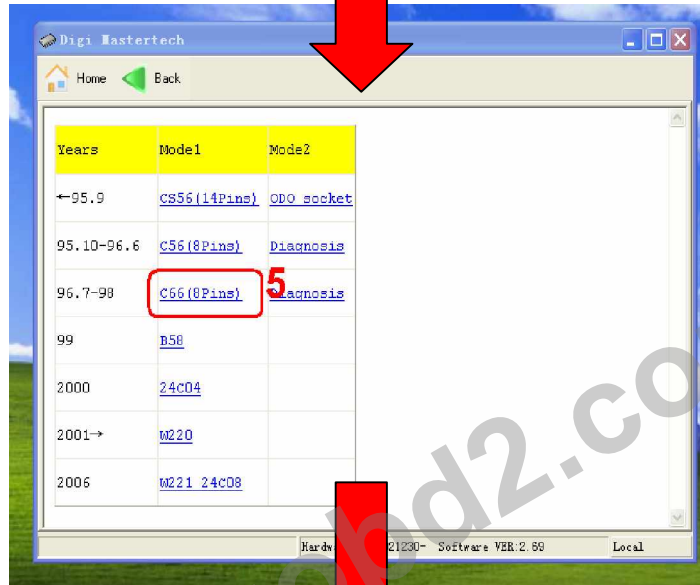

The image displays three sequential screenshots of the UOBD2 software interface, illustrating the process of mileage correction. Each screenshot shows a hex data dump and a hardware/software information bar at the bottom.

**First Screenshot:** The software displays a hex data dump. A 'Notice' dialog box is shown, stating: "Current detected mileage:49984KM,be sure to adjust?".

**Second Screenshot:** The software displays the same hex data dump. An 'Adjust odometer' dialog box is shown, with the 'Enter mileage:' field set to '12000'. The unit is set to 'Kilometer'.

**Third Screenshot:** The software displays the same hex data dump. A 'Wait' dialog box is shown, indicating 'Writing data into the device...' with a progress bar at 40% and a timer at 0.

Mileage correction succeeded!





China Auto Diagnostic Tool Centre

[www.uobd2.com](http://www.uobd2.com)

Install the IC onto the cluster; make sure to the direction of the IC is correct.

[www.uobd2.com](http://www.uobd2.com)

[www.uobd2.com](http://www.uobd2.com)