



K518ISE Key Programmer User Manual

This manual is specialized for Lonsdor K518ISE, please read it carefully before operating,
keep it well for further reference.

Lonsdor K518ISE Basics

Copyright

1. Lonsdor's entire contents, including but not limited to products or services, which are issued by or co-issued with the cooperation companies, and materials and software related to Lonsdor's affiliated companies, are copyrighted and protected by law.
2. No part of the above all shall be copied, modified, extracted, transmitted or bundled with other products, sold in any way or by any means without the written permission of Lonsdor.
3. Any infringement of the company's copyright and other intellectual property rights, Lonsdor shall seize its legal liability according to law.
4. Lonsdor 518ISE key programmer and related information, which should be used only for normal vehicle maintenance, diagnosis and testing, please do not use it for illegal purposes.
5. All information, specifications and illustrations in this manual are based on the latest configurations and functions available at the time of printing. Lonsdor reserves the right to make changes at any time when necessary without notice.

Disclaimer

Lonsdor shall not assume any incidental or consequential damages or any economic damages arising from the accidents of individual users and the third parties, as well as legal responsibilities, due to their misuse, unauthorized change or repair of the device, or abuse to violate laws and regulations. The product has a certain degree of reliability, but does not rule out the possible loss and damage. The risk arising from the user at their own risk, Lonsdor does not assume any risks and responsibilities.

K518ISE Main Unit Maintenance

- ✓ Place the equipment and accessories in a place where children are not accessible.
- ✓ Keep the equipment in dry and good ventilated environment. Do not use chemicals, detergents or water to clean the equipment, and avoid rain, moisture or liquid contained minerals to corrosion electronic circuit boards.
- ✓ Do not store the equipment in over hot/cold place as it will shorten the lifespan of electronic devices and damage the battery, the temperature range required: low temperature $(-10 \pm 3) ^\circ\text{C}$, high temperature $(55 \pm 3) ^\circ\text{C}$.
- ✓ Please do not disassemble the equipment personally, shall you have any problem, please contact after-sales service or the certified dealer.
- ✓ Do not throw, knock or strongly vibrate the device, it will damage the internal circuit board.
- ✓ If the equipment is in water, make sure it is disconnected and should not be disassembled personally. Do not use any heating equipment (dryer, microwave oven, etc.) to dry. Please send the device to local dealer for inspection.

- ✓ After a long time use, such as during working state, long charge, connect OBD to diagnose, the device may become a slight fever, this is a normal, please do not worry.
- ✓ The device has a built-in antenna, please do not damage or modify the antenna without authorization, to avoid performance degradation of the device and the SAR value exceeds the recommended range. As the antenna position will affect antenna performance, resulting in equipment transmission power in an unstable state, so please try to avoid holding the antenna area (upper right corner).
- ✓ Do not place heavy objects on the device or squeeze vigorously, to avoid device damage or display screen distortion.

Battery Maintenance

- ✓ When the device is in start state, please do not remove or maintain the battery. The inside polymer lithium battery, if not handled properly, may run the risk of fire or burning itself.
- ✓ Please do not disassemble the battery, do external short-circuit contact, or expose the battery at excessively high or low temperature (-10°C~55°C as suggested), and do not dispose battery in fire or as normal waste.
- ✓ Please be careful to keep the battery dry and away from water or other liquids, to avoid short circuit. If soaked, please do not start the device or remove the battery without direction.

Table of Contents

| | |
|---|-----------|
| Lonsdor K518ISE Basics..... | 1 |
| Copyright..... | 1 |
| Disclaimer..... | 1 |
| K518ISE Main Unit Maintenance..... | 1 |
| Battery Maintenance..... | 2 |
| 1. ABOUT LONSDOR K518ISE..... | 4 |
| 1.1 Introduction..... | 4 |
| 1.2 Accessories..... | 4 |
| 1.3 Application..... | 5 |
| 1.4 Feature..... | 5 |
| 1.5 Technical Parameter..... | 6 |
| 2. PRODUCT APPEARANCE..... | 6 |
| 2.1 Main Unit Appearance..... | 6 |
| 2.2 KPROG Adapter Appearance..... | 7 |
| 3. FUNCTION & OPERATION..... | 8 |
| 3.1 Registration & Activation..... | 8 |
| 3.1.1 Network setting..... | 8 |
| 3.1.2 System update..... | 8 |
| 3.1.3 Registration & activation..... | 8 |
| 3.2 Vehicle Connection..... | 9 |
| 3.3 Function Description..... | 10 |
| 3.4 Diagnosis description..... | 13 |
| 3.5 Adaptor Binding..... | 15 |
| 4. DISPOSAL..... | 15 |
| 5. CONTACT..... | 16 |
| Warranty Service Sheet..... | 17 |

1. ABOUT LONSDOR K518ISE

1.1 Introduction

Product Name: K518ISE Key Programmer

Product Description: Lonsdor K518ISE is designed specifically for the technician and locksmiths.

With tough host, powerful diagnostic functions, Android platform, wireless technology, convenient and fast online upgrade, integrated multi-function connector, K518ISE is a technologically innovative car key programming device for locksmith.

Anti-oil, dust, shock, drop, cold and high temperature.

Equipped with professional side backpack, more convenient and more efficient.

With flat ergonomic design, user can experience more humanized functions.

1.2 Accessories

After receiving the product, make sure you have all the following parts.

| Name | Number | Name | Number |
|-------------------|--------|---------------------|--------|
| Portable bag(Big) | 1 | Portable bag(Small) | 1 |
| Main Host | 1 | KPROG Adapter | 1 |
| Power Adaptor | 1 | RN-01 Board | 1 |
| USB Cable | 1 | E-01 Board | 1 |
| Packing Bundle | 1 | FS-01 Board | 1 |
| OBD test cable | 1 | 20P Cable | 1 |
| Extra Connector | 3 | Backup Pin | 5 |
| User Manual | 1 | Certificate | 1 |

Portable bag for convenient carrying and field testing.

Besides main unit, the main portable bag(the bigger one) includes items as below



Power Adaptor

USB Cable

Extra Connector

OBD test cable

Packing Bundle

The accessory portable bag(the small one) includes items as below:



KPROG Adapter

RN-01 Board

E-01 Board

FS-01 Board

20P Cable

1.3 Application

Lonsdor K518ISE Key Programmer is now basically used to the following fields:

- Immobilization
- Odometer adjustment

Cars Coverage List for Immobilization:

Europe:

Audi, BMW, Benz, VW, Volvo, Citroen, Ferrari, Maserati, Fiat, Lamborghini, Jaguar, MG, Land Rover, Bentley, Lancia, Opel, Peugeot, Porsche, DS, Renault, Alfa Romeo, Smart, Borgward

America:

Cadillac, Chevrolet, Dodge, GMC, Buick, Hummer, Ford, JEEP, Lincoln, Mercury

Asia:

Honda, Hyundai, Isuzu, KIA, Lexus, Mazda, Mitsubishi, Nissan, Ssangyong, Subaru, Suzuki, Toyota, Shigaoka Queen

China:

Iveco, Trumpchi, BYD, Geely, Chery, Great Wall, Young Lotus (Basically all Chinese car models are included)

Odometer Adjustment Car List:

VW, Porsche, Ford, Jaguar, Land Rover, Mazda, Audi, Renault, Hummer, Hyundai, Kia

Note: K518ISE is still under rapid upgrading, more functions and high end car models will be released soon, please refer to our website www.lonsdor.com for instant updating news, also you can “One key update” for the latest version by yourself.

1.4 Feature

- ◆ The best car diagnostic tool based on Android
- ◆ WIFI networking ensures software upgrading more convenient.
- ◆ No need to plug memory card, or connect the computer with data cable, more flexible in online upgrading, updating and activating.
 - ◆ With USB-B2.0 standard connector, OBD-II test cable integrated with the diagnostic connector function of the adapter.
 - ◆ Diagnostic speed greatly accelerated, work efficiency improved, better time saving.
 - ◆ 7 inches high brightness, high definition color IPS capacitive screen
 - ◆ 3800mAh polymer battery
 - ◆ Support external memory expansion, better within 32G

- ◆ Built-in professional, powerful operation assistant system

1.5 Technical Parameter

| | | | |
|---|--|------------------|---------------|
| RFID | Support: 125KHz ASK; 134.2KHz FSK | Battery capacity | 3800mAh |
| CPU | ARM Cortex-A7 Quad-core Processor Speed 1.34GHZ | Power supply | DC12V 1A |
| WIFI communication distance | 10m | Power port | 5.5x2.1mm ⊖—⊕ |
| Display | 1024x600, 7 inch IPS capacitive screen | OBD port | OBD-II |
| Memory | eMMC 8G RAM 1G | Comm port | USB2.0-type B |
| OBDII protocols: ISO15765, ISO9141, ISO14230, SAEJ1850, KW1281, VW TP1.6 TP2.0 etc. | | | |
| KPROG: support programming MCU and EEPROM on ECU circuit board. | | | |

2. PRODUCT APPEARANCE

2.1 Main Unit Appearance

K518ISE Front View

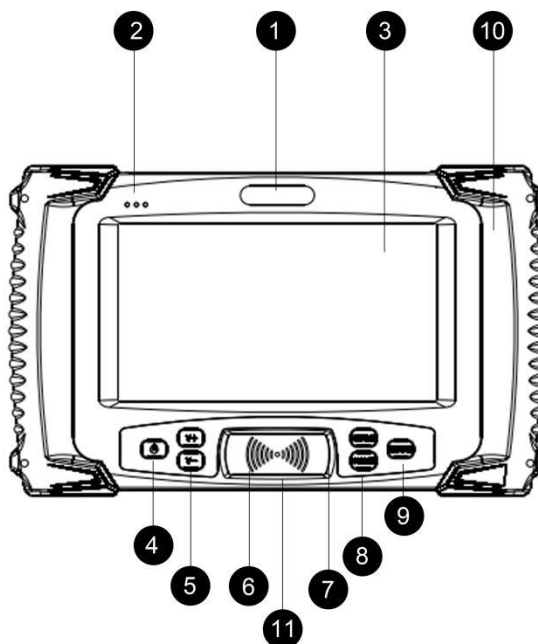

1. Trademark: Lonsdor

2. Three-color indicator in turn will be: red - external power supply; blue - system power; yellow - communication status
 3. Capacitive touch screen: display and touch operation function.
 4. Switch: press and hold for 3s to start. When in start state, press and hold for 3s to restart or shutdown, for 10s to force to restart.
 5. Volume: adjust volume size
 6. Key frequency & chip recognition system: place the key on the surface to detect frequency, push the slot shell to the right and put the key inside to detect chip
 7. Setting: enter to set
 8. Home: home page interface
 9. Return: back to previous step
 10. Built-in antenna: antenna inside
 11. Model: K518ISE
- Screen shot: press power button and volume down button together

K518ISE Top View

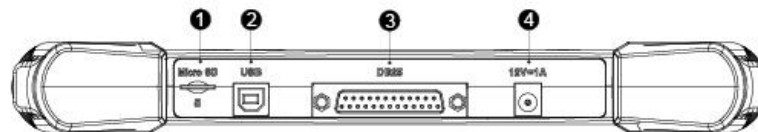

1. Power socket
2. SD card slot
3. DB25 port
4. USB port

2.2 KPROG Adapter Appearance

KPROG Adaptor Front View

1. Trademarks
2. Three-color indicator: red - power light; blue - data light; yellow - comm status light
3. Simple horn seat: to connect with 20P cable

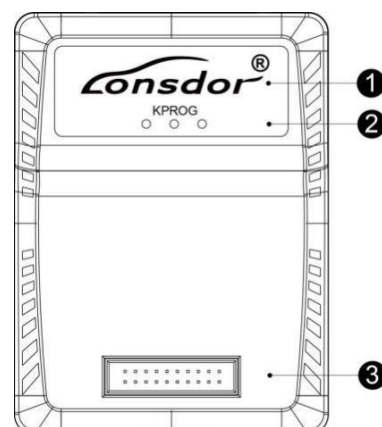

KPROG Adaptor UP View

1. Power socket
2. DB15 port
3. USB port

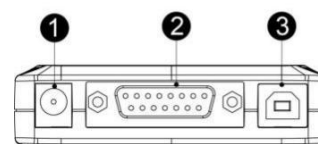

Functional accessories

RN-01 board: read & write CEM data

E-01 board: read & write EEPROM data

FS-01 board: read & write KVM data

20P cable: connect adapter with functional accessories

* The 3 extra connectors are for Honda(3-pin), Hyundai/Kia(10-pin)and Kia(20-pin) respectively.

Note: The above functional accessories are standard configurations, for more accessories, please contact dealer of Lonsdor to purchase.

As to usage and operation, please refer to“Function”or “Operation” menu in the diagnosis interface.

3. FUNCTION & OPERATION

Before using the device, you need first of all to set WIFI when you turn on the device, then go through the registration&activation process, make sure well connection between the device, OBD cable and the vehicle under proper circumstance.

3.1 Registration & Activation

In order to maintain user interests and rights, and to provide you with better service, please register/activate K518ISE before using it.

3.1.1 Network setting

First time to start the device, please set the network (connect available WIFI).

3.1.2 System update

After networking, the system will automatically updated to the latest version. There are 3 ways of system update:

- ✓ One key update: quickly update the new added or modified functions.
- ✓ APK update: this is used when the APK is updated.
- ✓ Force to update: this is used when the device is faulty or to retrieve data.

3.1.3 Registration & activation

After system updating, you need go to registration&activation. For new user, click **Registration**, input user name(email), name(min 2 char), password(min 6 char), email verification code and click YES to complete registration(if interrupted after registration is done, you will go to the **System update--Registered user** to proceed). Then go to **Activation confirmation** to continue.

After confirming activation, it will enter into **Setup password** interface, please set 6-digit numbers as your startup password. Then after information verification by Lonsdor (5-30 minutes, you can check the progress by clicking “Refresh”), you will required to re-enter the password to verify, when you get the notification that verification successful, the whole process before using the device is complete.

Note

1. User name must be available email address, so that you can receive the verification code

from Lonsdor by email.

2. Please pay attention to the difference between the registration password (min 6 char) and the startup password(6-digit), the former will generally only used when registration, so please commit the 6-digit startup password into memory, as this will be required every time when you start the device.
3. The account will be bound to the corresponding device for life, other accounts can not log in your device and your account can not log in an registered or activated device either.
4. An account can be used to bind multiple new devices.

3.2 Vehicle Connection

For the OBD test cable, there are 3 connectors:

Connector 1: connect K518ISE OBD port;

Connector 2: connect KPROG adaptor

Connector 3: connect the vehicle OBD port



Before using the device, you need to make sure well connection between the device and the car. Please use the OBD cable to connect the device OBD port and the car OBD port as below:

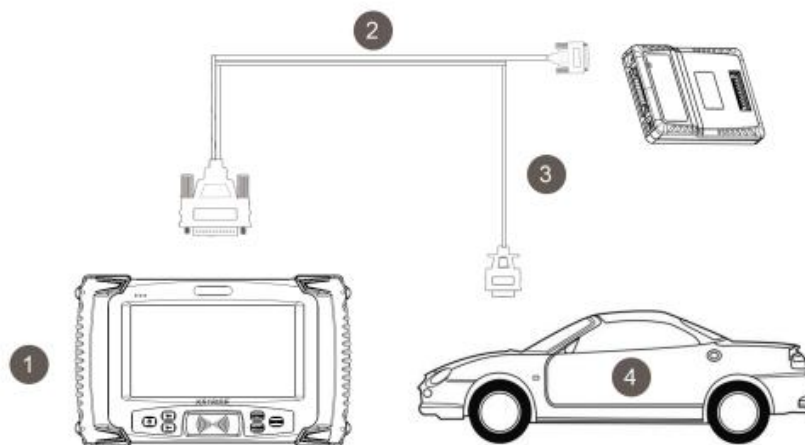

- | | |
|----------------------|-------------------|
| 1. K518ISE main unit | 2. OBD test cable |
| 3. OBD II connector | 4. Vehicle |

Note

1. The vehicle power supply has to meet the normal voltage limit, i.e. around DC 12V.
2. Make sure the red indicator is on(the 1st of the 3 color indicators on the left corner)
3. If it still can not work, please check the vehicle OBD port and related wire connections to pinpoint the problem.
4. the KPROG adaptor is needed only when it is available for certain car series.

3.3 Function Description

- Please pay attention to below function description before using the device.
- Immobilization: immobilizer system diagnosis
- Odometer adjustment: mileage diagnosis and correction
- Hardware testing: test if the hardware can function well
- Adapter: after dismantling, diagnose certain car models
- Setting: set up basic device information
- Update firmware: adapter firmware upgrade & update (connect KPROG adapter with OBD test cable and connect K518ISE with 12V power supply)
- One key upgrade: click to update to the latest system data
- Shutdown - turn off the device

Main interface:

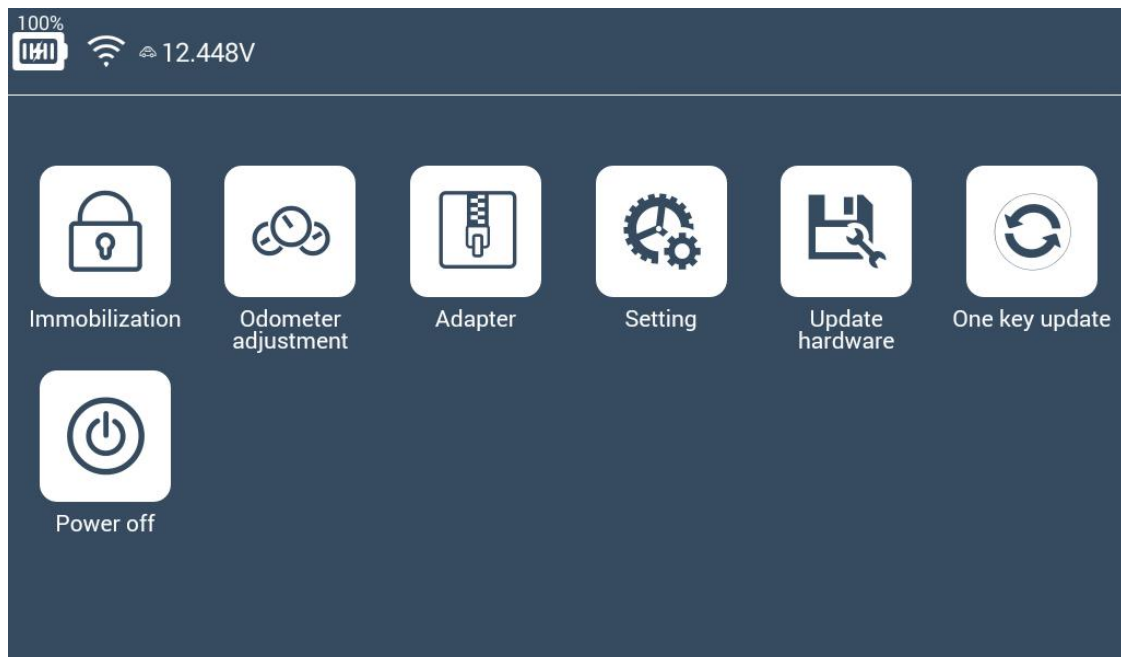

Immobilization interface:

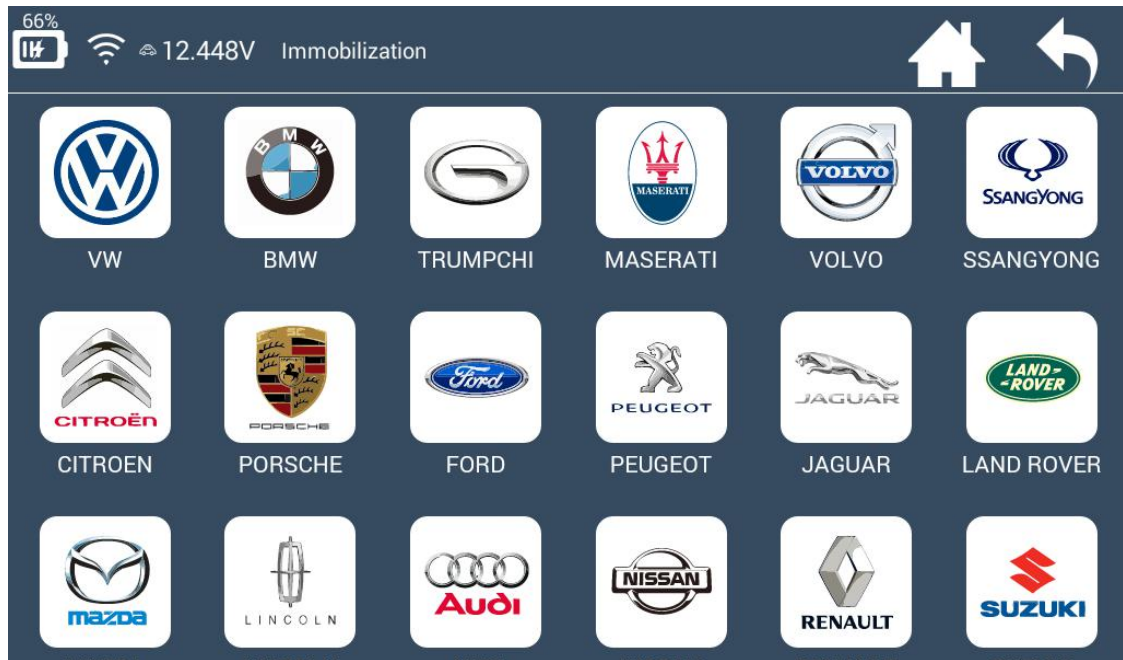

Odometer adjustment interface:

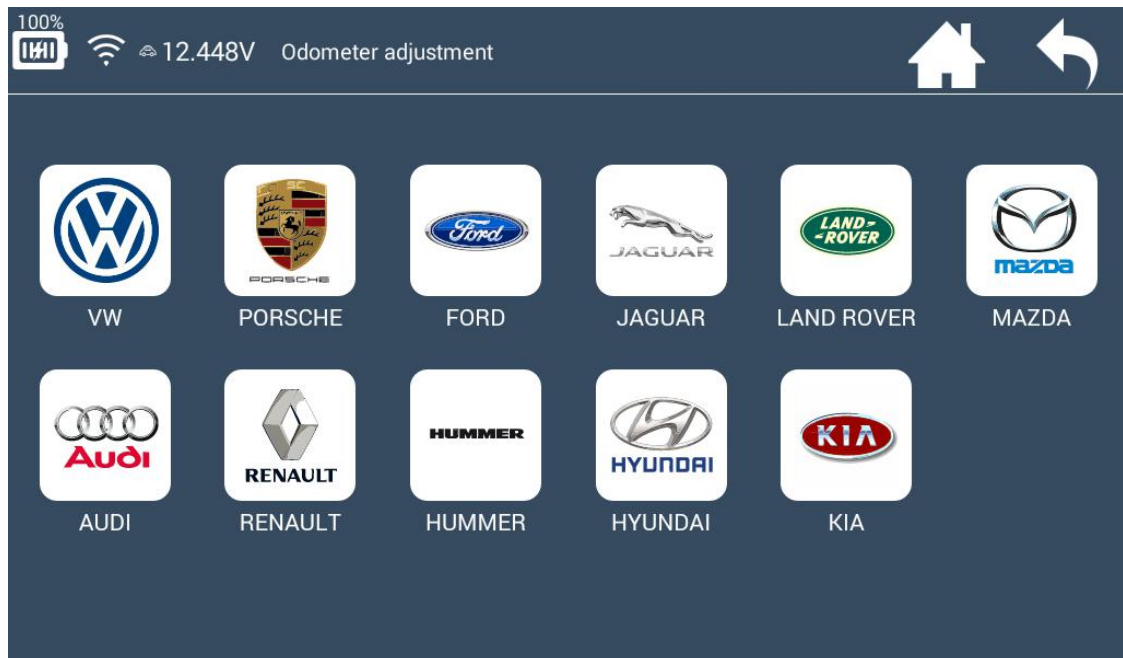

Setting interface:

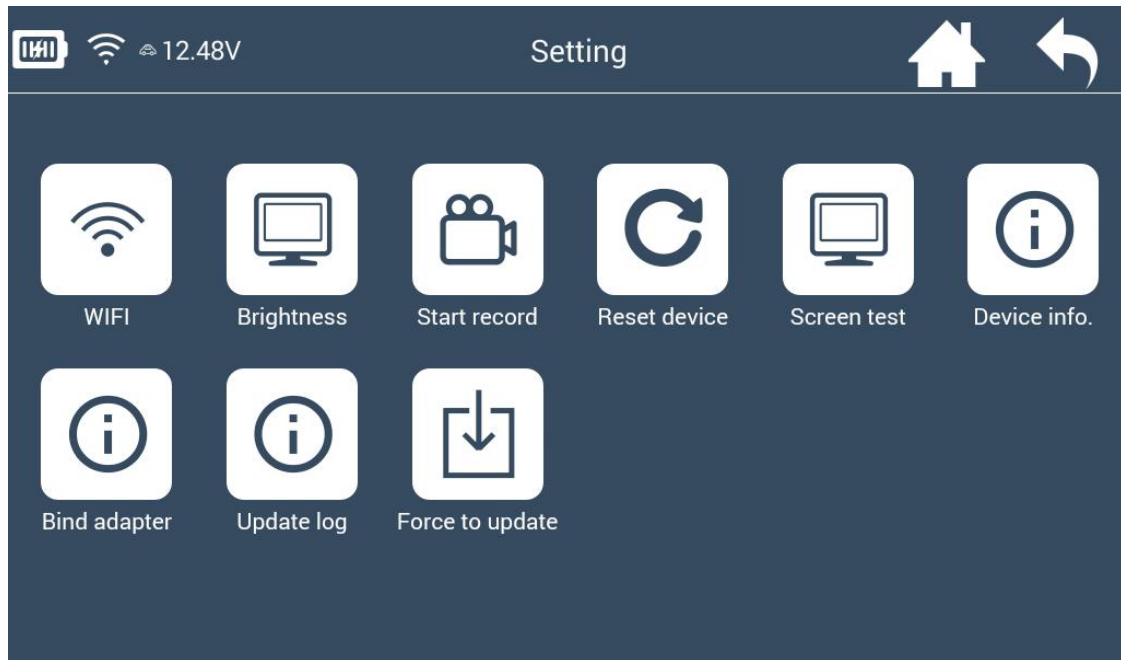

- WIFI: detects and connects available wireless network

Brightness: to adjust screen brightness

- Start recording: click to start recording, enter “Immobilization”, “Odometer adjustment” or other systems to operate, the operation process will be recorded

➤ Reset: situations such as program error, system crashes, communication failure, etc., can be returned to normal state

- Screen test: screen touch diagnosis

- Device Information: view information such as the device ID, PSN, etc.

- Bind adapter: first use, the adapter must be bound to K518ISE (refer to “3.5

Adaptor Binding”)

- Update log: update system log

- Force to update: this is used when the device is faulty or to retrieve data

3.4 Diagnosis description

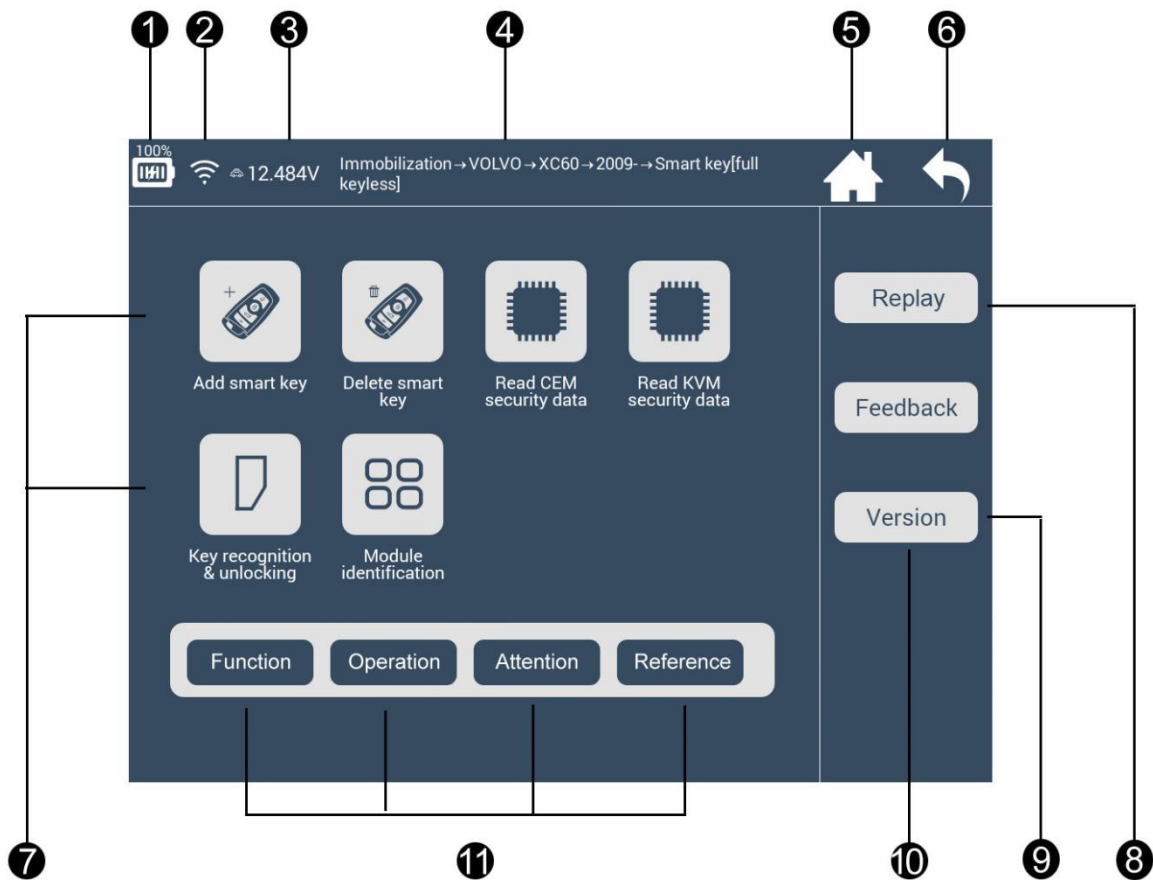

1. Power supply
2. WIFI signal
3. Device voltage
4. Navigation bar
5. Return to home page
6. Return to the previous menu

7. Diagnosis function

Diagnosis functions basically refer to key programming, pin code reading, key unlocking, and immobilization, as to the exact functions, it will be various according to different vehicles and types.

8. Function demo video (with instructions)

9. Feedback

10. Version: detect the latest version of the current interface functions

11. Diagnosis functions and related model info.(with instructions)

Function: to illustrate each function, and the necessary tips for certain functions.

Operation: to give concrete guide for each step, some pictures and notices are attached if necessary.

Attention: to emphasize all the tips and notices for all the functions, special attentions for each step, as well as possible user overlook during operation which may cause program failure.

Reference: to provide the basic information like chip type, frequency, key embryo no., PIN code requirement, car photo, OBD position and other related information.

Function demonstration

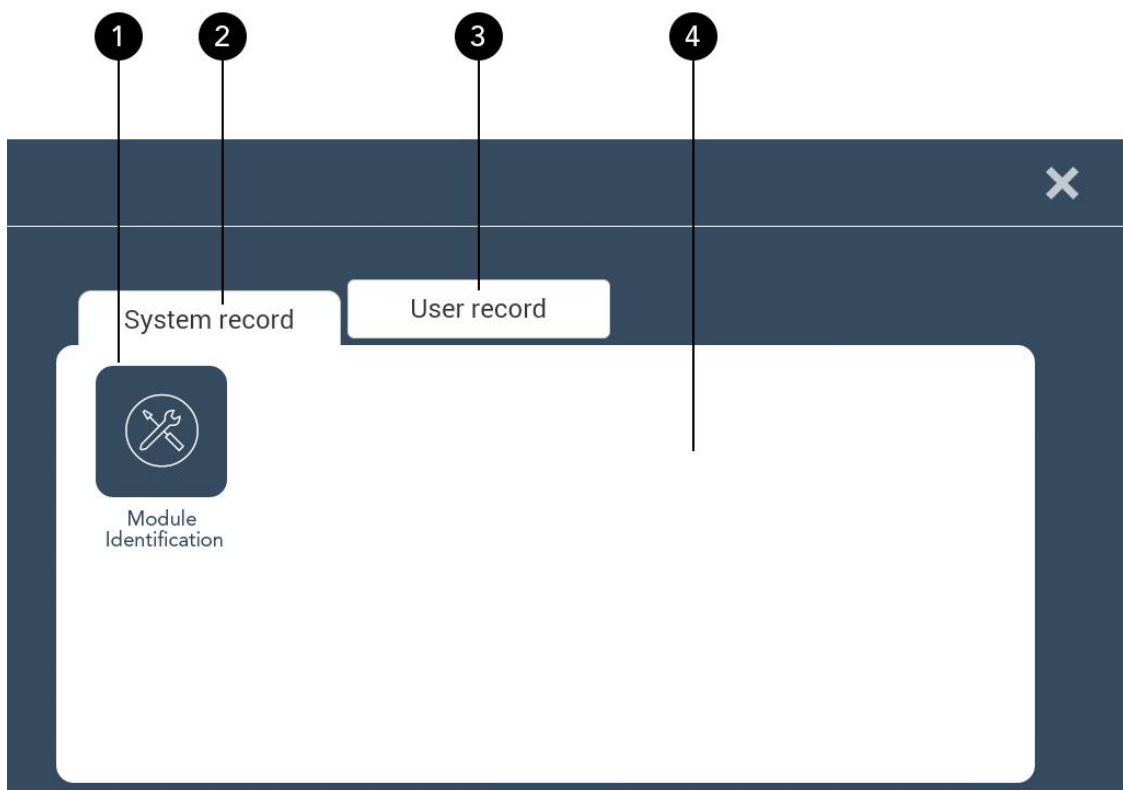

1. Click the menu to view the relevant function demo video (suspend or exit)
2. System record: system demo video (nondeletable)
3. User record: user self-recording video (press 5s to delete)
4. In the 3 “Delete-able state”, click on the blank to cancel the “delete”

Reference interface

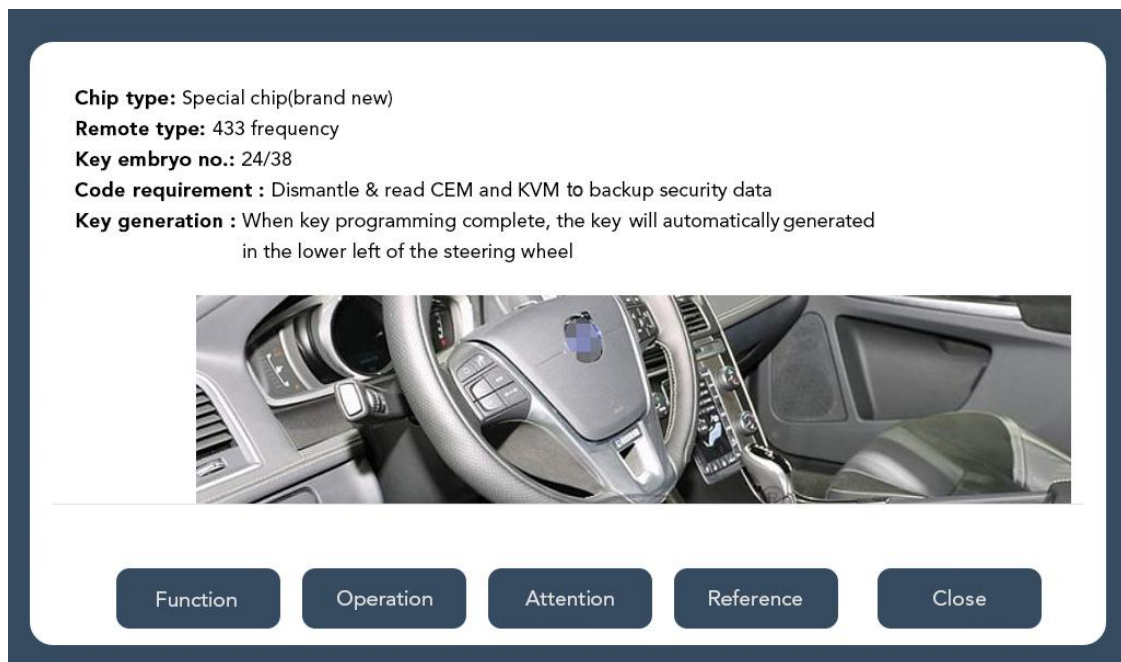

3.5 Adaptor Binding

Please note that KPROG adapter must be bound to K518ISE before using, here is the binding process:

- Step 1. Connect adapter to K518ISE with mainline
- Step 2. Connect K518ISE with 12V power supply
- Step 3. Enter into "Setting"
- Step 4. Click "Bind adapter"
- Step 5. Click "OK" to complete

Note: The KPROG adapter is specialized for part of Volvo car series and the new Maserati for the time being, we are still developing some more car models that the adaptor can support in the near future, such as Jeep Grand Cherokee, please refer to our website or directly go to the "One key update" for latest news.

4. DISPOSAL

As the product is electronics, considering environment protection and material recycle, when the device is discarded, it is recommended to resort to the local distributor or qualified waste collection department to proceed.

* Lonsdor retains the final interpretation of the above terms.

5. CONTACT

Shenzhen Lonsdor Technology Co., Ltd.

Web: www.lonsdor.com

Email: service@lonsdor.com

Add.: Shenzhen, China

Lonsdor K518ISE

Warranty Service Sheet

Customer Name: _____ (Mr. / Ms.)

Mob: _____

Email: _____

Address: _____

Device Model: _____

Serial No.: _____

Returned items details: _____

Problem description in detail: _____

Sending date: _____

Sender Signature: _____